

# ENT EAR

CATALOGUE



# ENT-EAR

1- Scissors .....	01
2- Needles.....	02-03
3- Tissue, Dressing and Sponge Forceps.....	04-07
4- Alligator Forceps.....	08-14
5- Nippers, Crimping Forceps and Snares.....	15-18
6- Hooks and Probes.....	19-20
7- Retractors .....	21-22
8- Picks.....	23-26
9- Specula.....	27-32
10- Cotton Applicators.....	33
11- Knives.....	34-40
12- Suction Irrigation.....	41-44
13- Dissectors, Chisels and Gouges.....	45-46
14- Elevators, Scrapers and Excavators.....	47-48
15- Augers, Measurers and Rasps .....	49
16- Curettes, Loops and Spoons.....	50-54
17- Rongeurs.....	55
18- Tuning Forks.....	56
19- Miscellaneous.....	57-58

## ENT-EAR Scissors

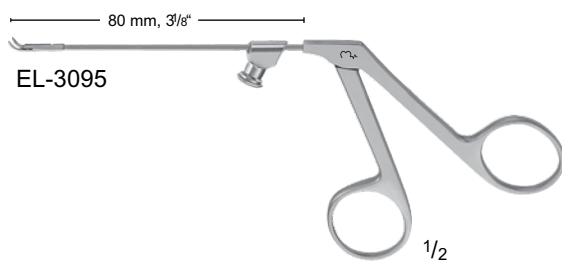
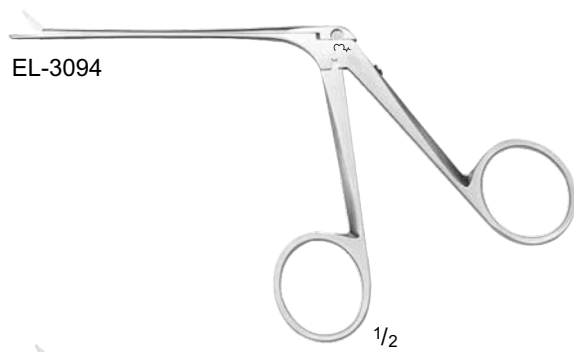
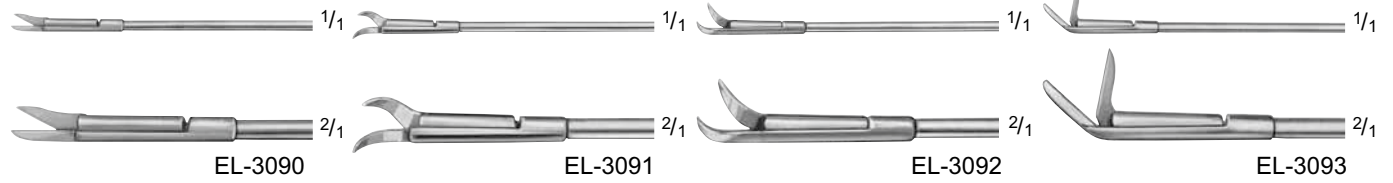
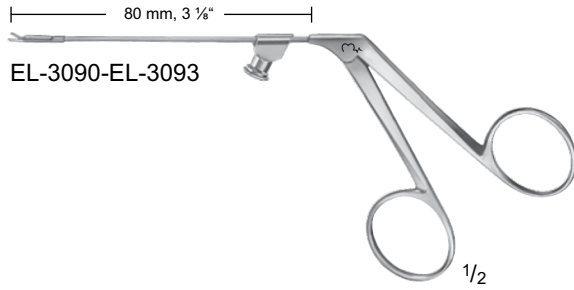

### BELLUCCI Micro Scissors

Catalog Number	Tip	Blade	Working Length (in.)	Length (in.)
EL-3090	S/S	STR	3 1/8	5 1/4
EL-3091	S/S	CVD-LEFT	3 1/8	5 1/4
EL-3092	S/S	CVD-RIGHT	3 1/8	5 1/4
EL-3093	B/B	ANG-UP	3 1/8	5 1/4

### BELLUCCI Scissors

Catalog Number	Tip	Blade	Blade Size (mm)	Working Length (in.)	Length (in.)
EL-3094	B/B	STR	7	3	5 1/4
EL-3095	S/S	CVD-UP	-	3 1/8	5

### WIET Ear Scissors, Bayonet-Shaped

Catalog Number	Tip	Blade	Length (in.)
EL-3096	S/S	STR	6 1/2



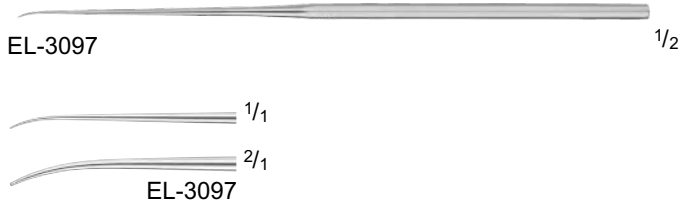

**HOUSE Needle**

Catalog Number	Tip	Blade Shape	Length (in.)
EL-3097	DEL	CVD	6 1/2

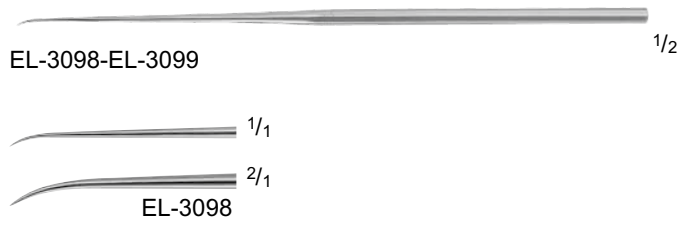

**HOUSE Needle, Malleable**

Catalog Number	Tip	Blade Angle	Length (in.)
EL-3098	SEMI-SHARP	CVD	6 1/2
EL-3099	W/ ROSEN POINT, SEMI-SHARP	CVD	6 1/2

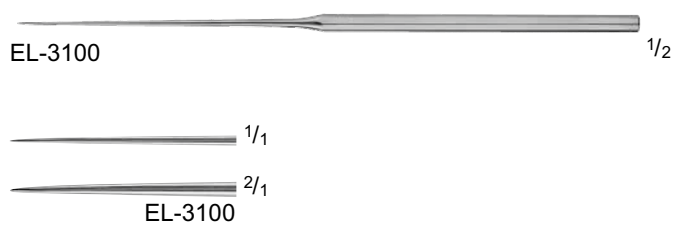

**HOUSE-BARBARA Needle**

Catalog Number	Tip	Blade Angle	Length (in.)
EL-3100	SHARP	STR	6 1/2

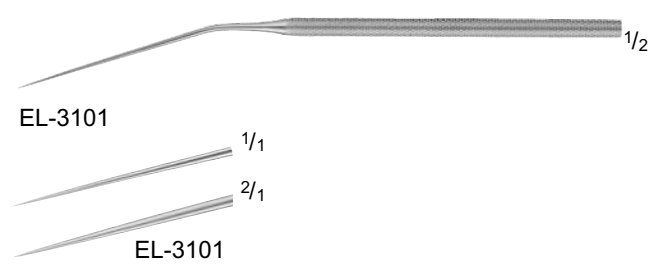

**MCGEE Perforating Needle**

Catalog Number	Tip	Blade Angle	Length (in.)
EL-3101	SHARP	ANG 20°	6 3/8

## ENT-EAR Needles

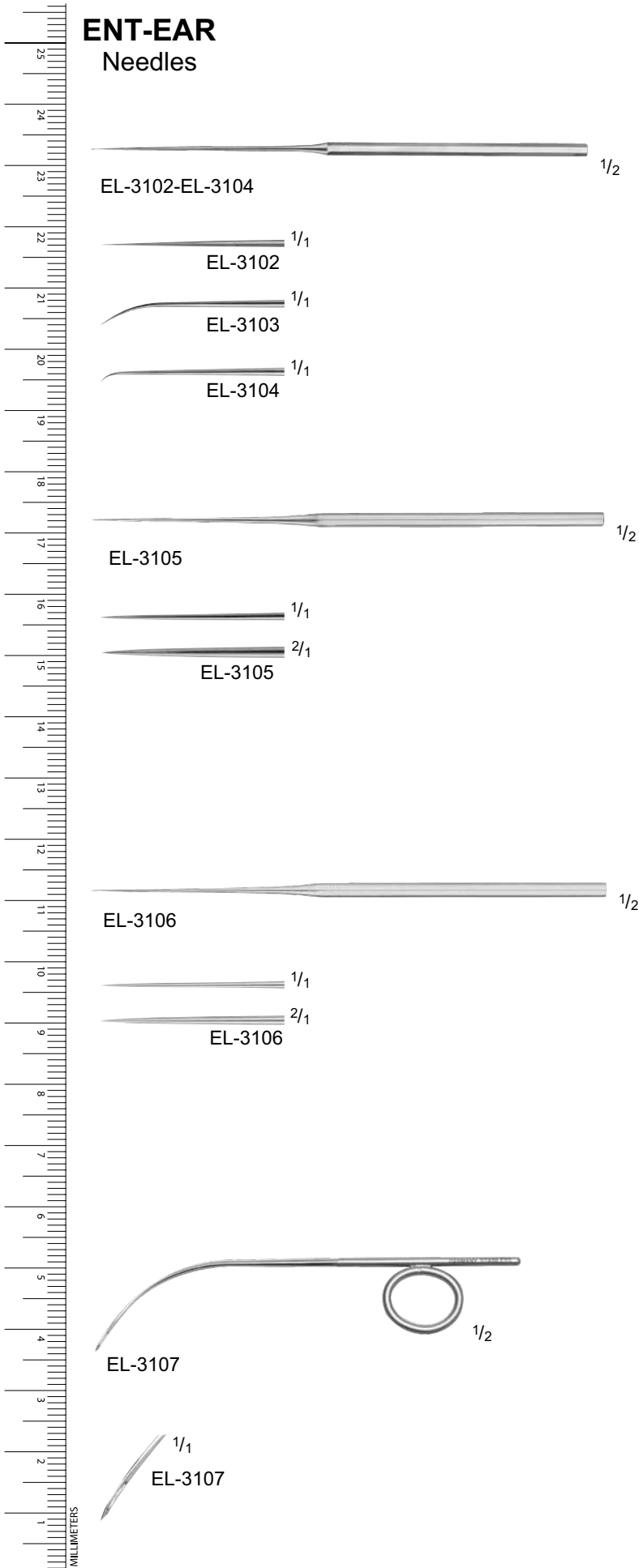

### Micro Needles

Catalog Number	Tip	Blade Angle	Length (in.)
EL-3102	SHARP-POINT	STR	6 1/4
EL-3103	SHARP-POINT	CVD	6 1/4
EL-3104	SHARP-POINT	HEAVY-CVD	6 1/4

### PAPARELLA Needle, Malleable, Heavy

Catalog Number	Tip Size (#)	Blade Angle	Working Length (in.)	Length (in.)
EL-3105	6	STR	2 3/4	6 1/2

### SAUNDERS-PAPARELLA Needle, Malleable, Fine

Catalog Number	Tip Size (#)	Blade Angle	Working Length (in.)	Length (in.)
EL-3106	5	STR	2 3/4	6 1/2

### WRIGHT Fascia Needle

Catalog Number	Tip	Tip Size (mm)	Length (in.)
EL-3107	CVD	2	5 1/8

## ENT-EAR

### Tissue/Dressing/Sponge Forceps



EL-3108

1/2



EL-3108

1/1

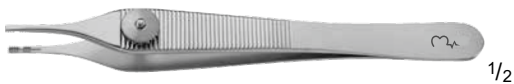

EL-3109

1/2



EL-3109

1/1



EL-3110

1/2



EL-3110

1/1

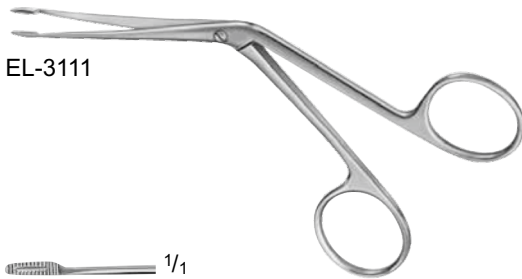

EL-3111

1/2



EL-3111

1/1

### SHEEHY Ossicle Holding Forceps

Catalog Number	Length (in.)
EL-3108	4 3/4

### DERLACKI Ossicle Holding Forceps

Catalog Number	Tip	Length (in.)
EL-3109	1 MM TEETH W/ VERTICAL AND HORIZONTAL GROOVE	5

### HARTMANN Tampon Forceps

Catalog Number	Tip	Length (in.)
EL-3110	HEAVY	5
EL-3111	DELICATE	5 1/4



## ENT-EAR

### Tissue/Dressing/Sponge Forceps

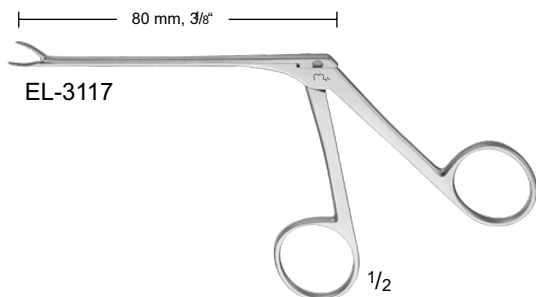
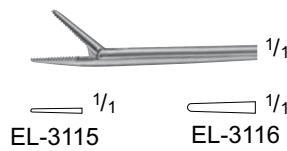
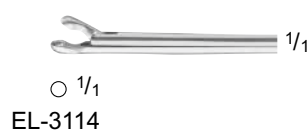
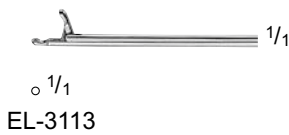
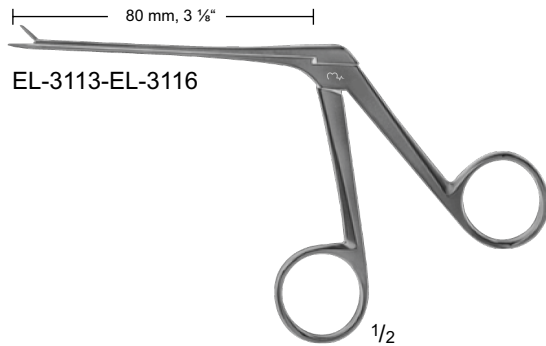
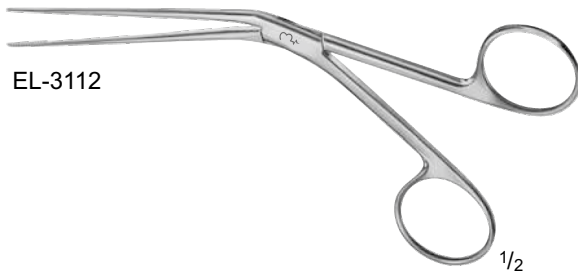

### TILLEY Ear Tampon Forceps

Catalog Number	Tip	Length (in.)
EL-3112	X-DEL	5 1/2

### HARTMANN-WULLSTEIN Ear Forceps

Catalog Number	Tip Size (mm)	Jaw	Working Length (in.)
EL-3113	1	STR, CUP	3 1/8
EL-3114	2	STR, CUP	3 1/8
EL-3115	0.5 x 6	STR, SERR	3 1/8
EL-3116	1 x 8	STR, SERR	3 1/8

### WEINGARTNER Ear Forceps

Catalog Number	Jaw	Working Length (in.)
EL-3117	SERR	3 1/8

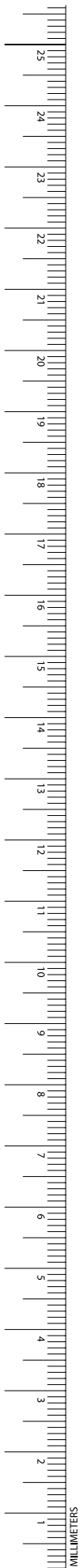

## ENT-EAR

### Tissue/Dressing/Sponge Forceps

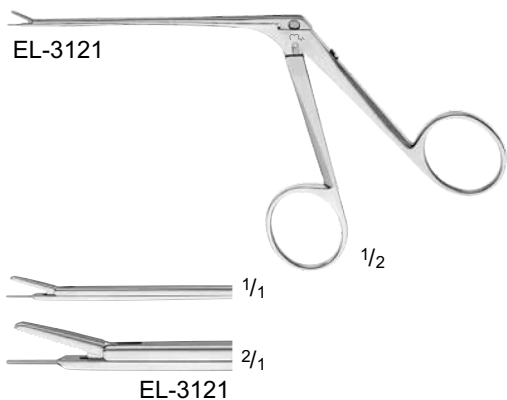
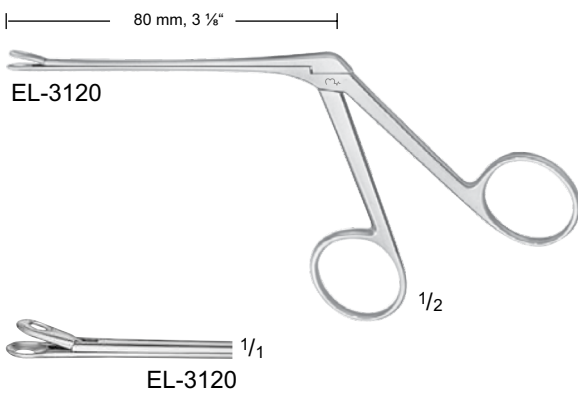
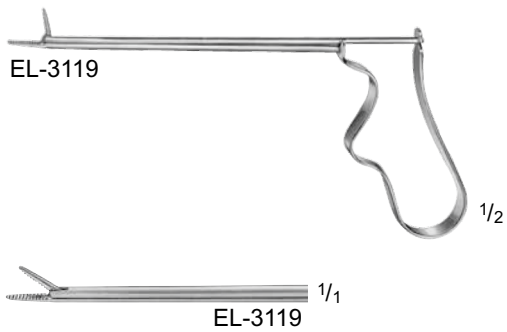
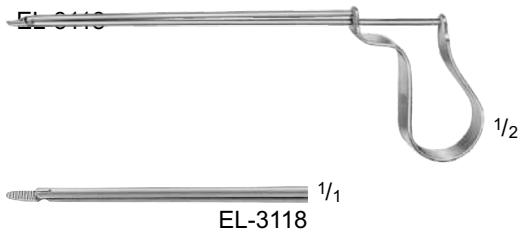

### QUIRE Foreign Body Forceps

Catalog Number	Working Length (in.)	Length (in.)
EL-3118	3 1/2	4 3/4

### BUCK Alligator Forceps

Catalog Number	Working Length (in.)	Length (in.)
EL-3119	1 7/8	3 1/2

### HENCKEL Spoon Forceps

Catalog Number	Tip Size (mm)	Jaw	Working Length (in.)
EL-3120	3 x 5	FLAT, OVAL SPOON	3 1/8

### LEIVERS Vent Tube Introducer Forceps

Catalog Number	Working Length (in.)	Length (in.)
EL-3121	2 7/8	5 3/8





# ENT-EAR

## Tissue/Dressing/Sponge Forceps

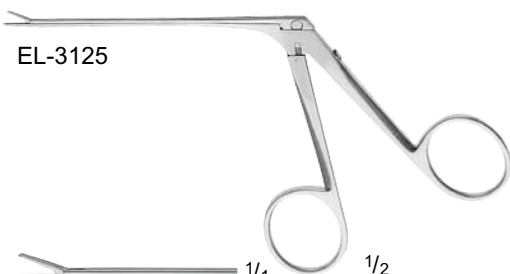
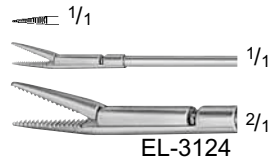
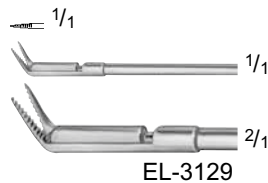
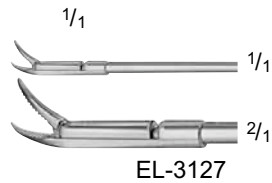
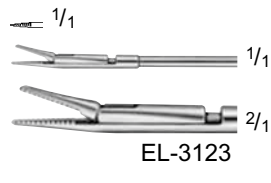
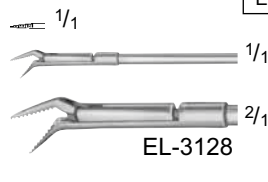
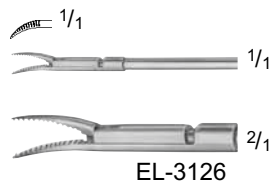
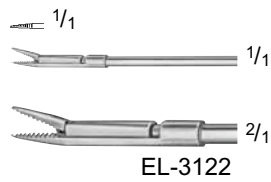
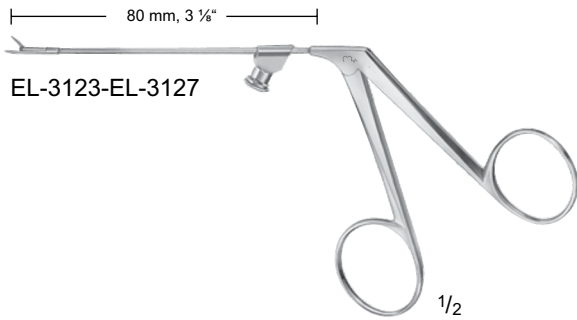
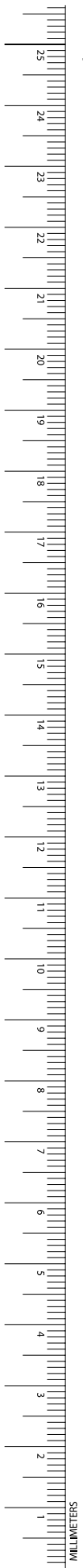

### Alligator Forceps, Serrated

Catalog Number	Tip Size (mm)	Jaw	Working Length (in.)
EL-3122	0.8 x 3.5	STR	3 1/8
EL-3123	1 x 5	STR	3 1/8
EL-3124	1.5 x 6.0	STR	3 1/8
EL-3125	4	STR	3 1/8
EL-3126	1 x 5	CVD-LEFT	3 1/8
EL-3127	1 x 5	CVD-RIGHT	3 1/8
EL-3128	0.8 x 3.5	ANG-DOWN 45°	3 1/8
EL-3129	0.8 x 3.5	ANG-UP 55°	3 1/8
EL-3130	4	ANG-UP	3 1/8

# ENT-EAR Alligator Forceps

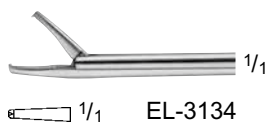
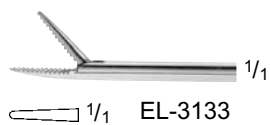
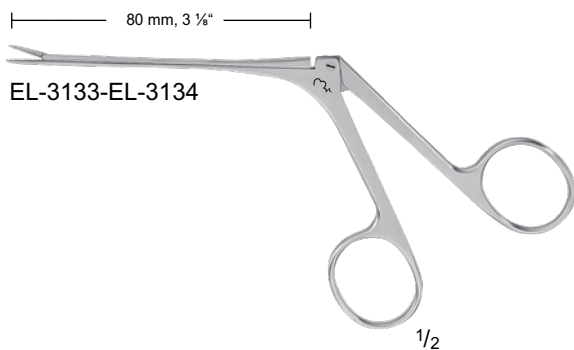

## BELLUCCI Alligator Ear Forceps

Catalog Number	Tip Size (mm)	Jaw	Working Length (in.)
EL-3131	8	STR, SERR	3 1/4

## Alligator Ear Forceps, Ebony

Catalog Number	Tip Size (mm)	Jaw	Working Length (in.)
EL-3132	0.8X4.5	STR, SERR	3

## HARTMANN Ear Forceps

Catalog Number	Tip Size (mm)	Jaw	Working Length (in.)
EL-3133	1 x 8	STR, SERR	3 1/8
EL-3134	1 x 8	STR, 1 x 2 TEETH	3 1/8



## ENT-EAR Alligator Forceps

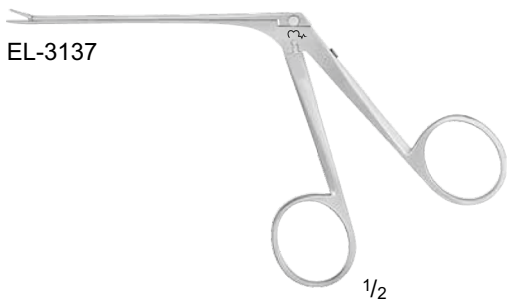
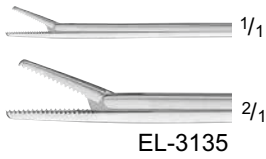
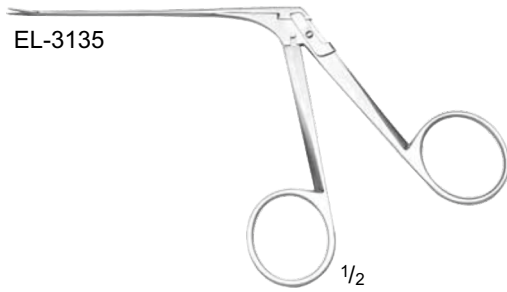
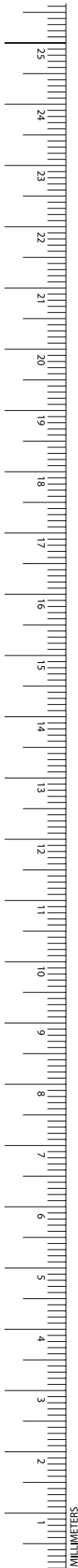

### HOUSE Alligator Ear Forceps, Horizontal Opening

Catalog Number	Tip Size (mm)	Jaw	Working Length (in.)
EL-3135	6	SERR	3 1/8

### HOUSE Miniature Alligator Ear Forceps, Delicate

Catalog Number	Tip Size (mm)	Jaw	Working Length (in.)
EL-3136	4	SERR	3 1/8

### HOUSE Strut Forceps

Catalog Number	Tip Size (mm)	Jaw	Working Length (in.)
EL-3137	6	SERR,SMOOTH	3 1/8



EL-3138



EL-3139

**NOYES Ear Forceps**

Catalog Number	Tip Size (mm)	Jaw	Working Length (in.)
EL-3138	6	SERR	3
EL-3139	7	SERR, 1 x 2 TEETH	3

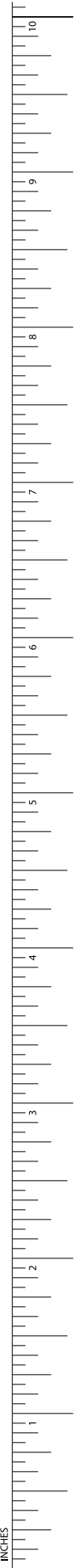

## ENT-EAR

### Alligator Cup and Punch Forceps

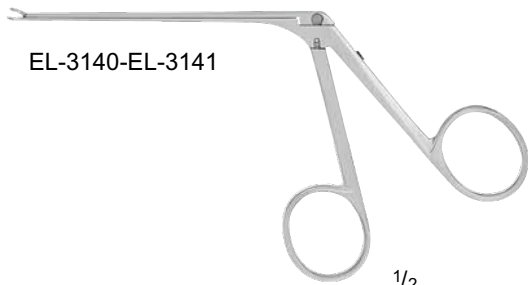
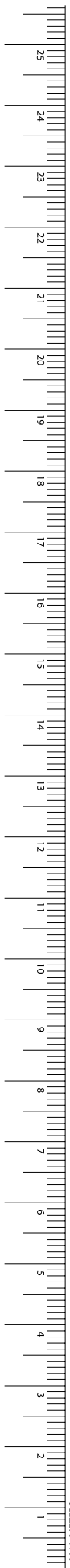

### Cup Forceps

Catalog Number	Jaw	Cup Size (mm)	Working Length (in.)
EL-3140	FINE	0.7 x 1.0	2 3/4
EL-3141	EXTRA FINE	0.9 x 2.0	2 3/4

### HARTMANN-HERZFELD Cup Forceps

Catalog Number	Jaw	Cup Size (mm)	Working Length (in.)
EL-3142	STR	1.5	3 1/8
EL-3143	STR	3.0	3 1/8
EL-3144	UPBITE	2.0	3 1/8

## ENT-EAR

### Alligator Cup and Punch Forceps

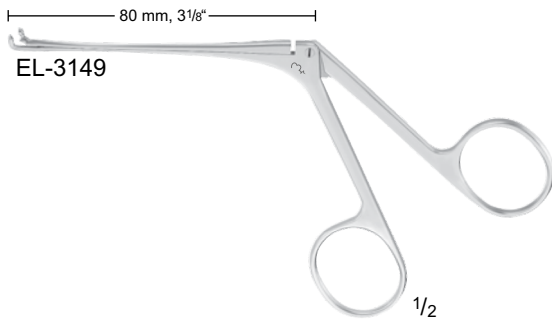
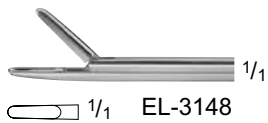
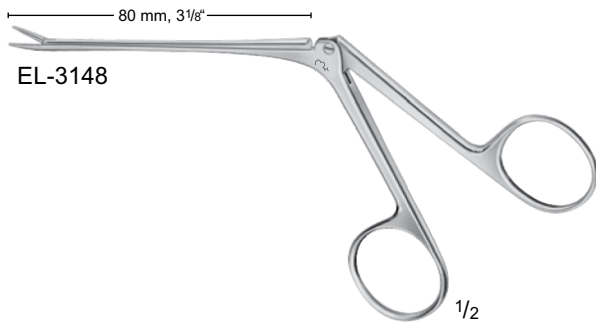
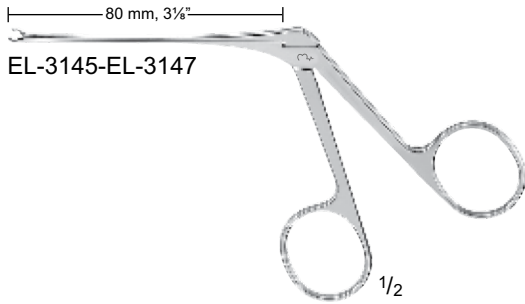

#### HARTMANN Cup Forceps

Catalog Number	Cup Size (mm)	Jaw	Working Length (in.)
EL-3145	2.0	STR	3 1/8
EL-3146	2.5	STR	3 1/8
EL-3147	3.0	STR	3 1/8

#### HARTMANN Forceps, Oval

Catalog Number	Cup Size (mm)	Jaw	Working Length (in.)
EL-3148	2 x 7	STR	3 1/8

#### HARTMANN-CITELLI Cup Forceps

Catalog Number	Cup Size (mm)	Jaw	Working Length (in.)
EL-3149	2.0	UPBITE	3 1/8



## ENT-EAR Alligator Cup and Punch Forceps

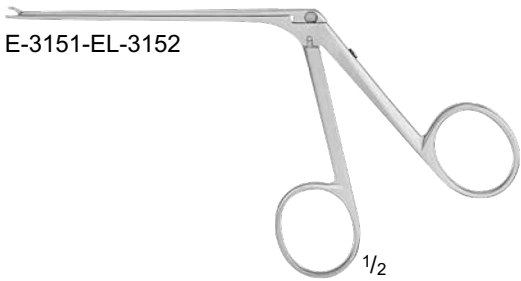

### HOUSE Cup Forceps, Miniature

Catalog Number	Cup Size (mm)	Jaw	Working Length (in.)
EL-3150	0.6 x 1.0	STR	3 1/8
EL-3151	0.6 x 1.0	ANG 15° LEFT	5 1/8
EL-3152	0.6 x 1.0	ANG 15° RIGHT	5 1/8

### HOUSE Oval Cup Forceps

Catalog Number	Cup Size (mm)	Jaw	Working Length (in.)
EL-3153	0.9	ANG 15° LEFT	2 3/4
EL-3154	0.9	ANG 15° RIGHT	2 3/4

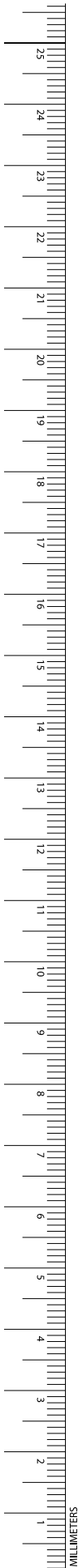

## ENT-EAR

### Alligator Cup and Punch Forceps

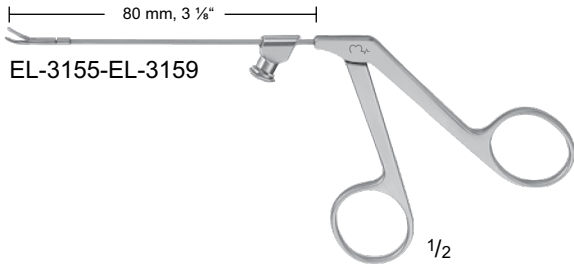

#### WULLSTEIN Micro Cup Forceps

Catalog Number	Cup Size (mm)	Jaw	Working Length (in.)
EL-3155	0.8 x 1.3	STR	3 1/8
EL-3156	1.7 x 2.5	STR	3 1/8
EL-3157	0.8 x 1.3	CVD-LEFT	3 1/8
EL-3158	0.8 x 1.3	CVD-RIGHT	3 1/8
EL-3159	1.0	STR ROUND	3 1/8

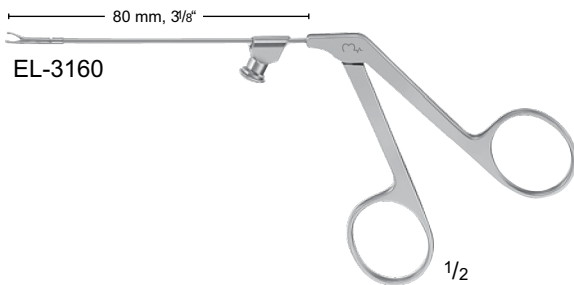
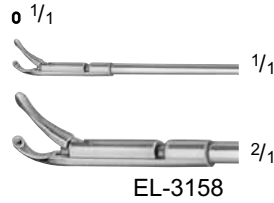
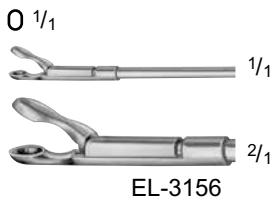
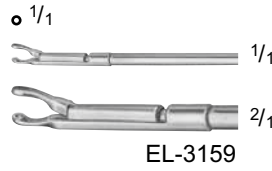
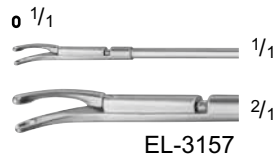
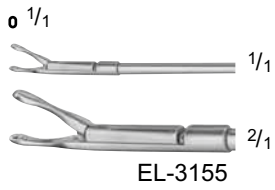

#### Micro Cup Forceps

Catalog Number	Cup Size (mm)	Jaw	Working Length (in.)
EL-3160	0.9 x 1	STR	3 1/8
EL-3161	0.9 x 1	CVD, UP	3 1/8

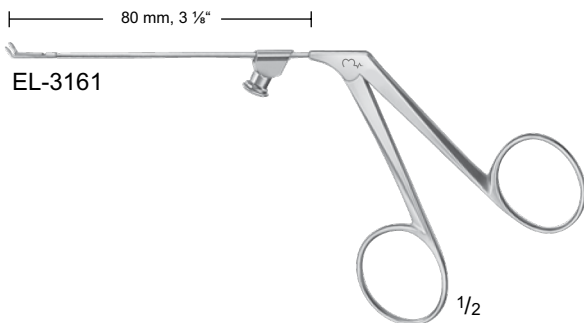

INCHES



## ENT-EAR

### Nippers/Crimping Forceps/Wire Guides/Cutters/Snares

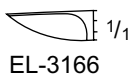
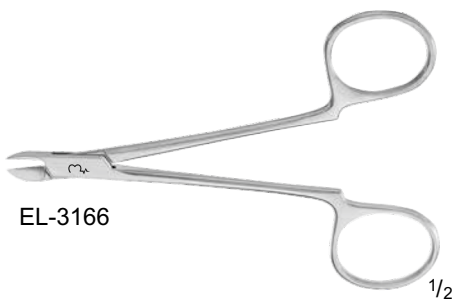
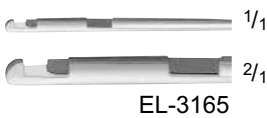
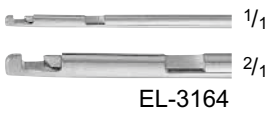
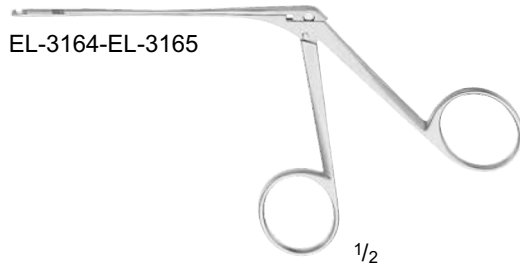
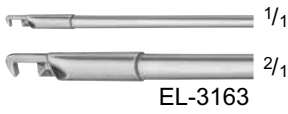
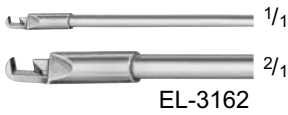
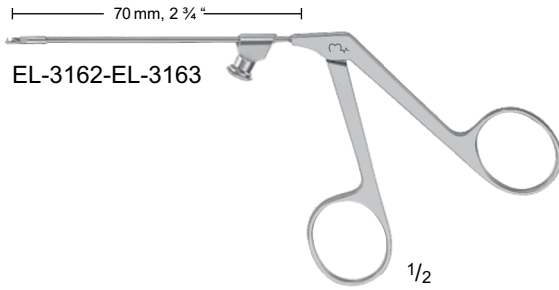

#### DIETER Malleus Nipper

Catalog Number	Tip	Working Length (in.)
EL-3162	UP BITE	2 3/4
EL-3163	DOWN BITE	2 3/4

#### HOUSE-DIETER Malleus Nipper

Catalog Number	Jaw Length (mm)	Working Length (in.)
EL-3164	1.5	3 1/8
EL-3165	2.0	3 1/8

#### LEMPERT Malleus Cutter

Catalog Number	Jaw Length (mm)	Length (in.)
EL-3166	11	4 1/2



## ENT-EAR

### Nippers/Crimping Forceps/Wire Guides/Cutters/Snares

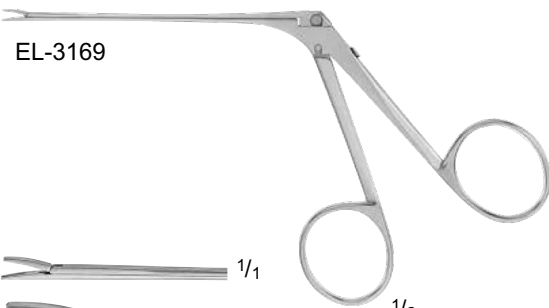
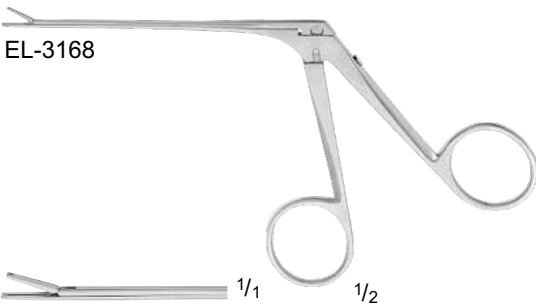
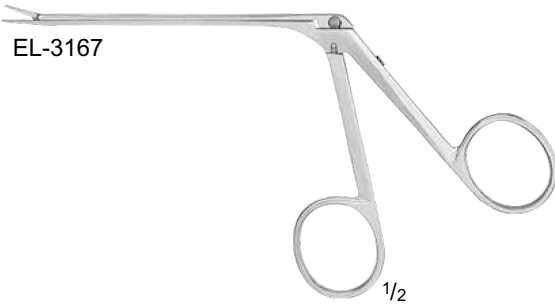

#### HOUSE Alligator Crimper

Catalog Number	Jaw Length (mm)	Tip	Working Length (in.)	Length (in.)
EL-3167	8	SERR	27/8	5 1/8

#### SCHEER Wire Crimper

Catalog Number	Jaw Length (mm)	Tip	Working Length (in.)	Length (in.)
EL-3168	7	SMOOTH	3 1/4	5 1/8

#### SCHUKNECHT Wire Crimper

Catalog Number	Jaw Length (mm)	Working Length (in.)	Length (in.)
EL-3169	3	3 1/8	5 1/8

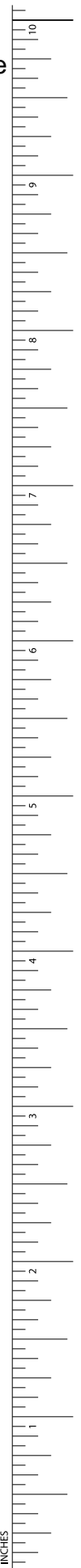

## ENT-EAR

### Nippers/Crimping Forceps/Wire Guides/Cutters/Snares

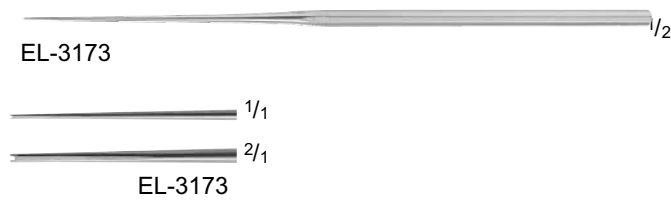
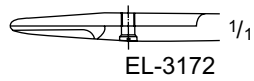
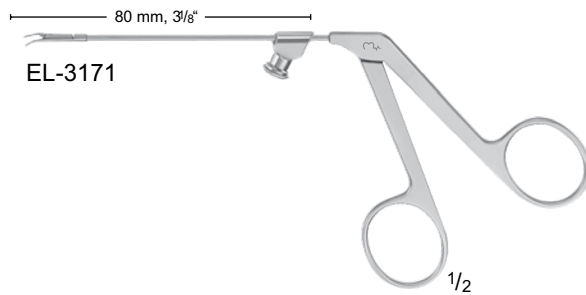
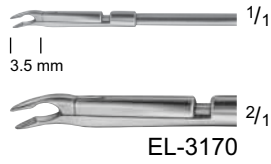
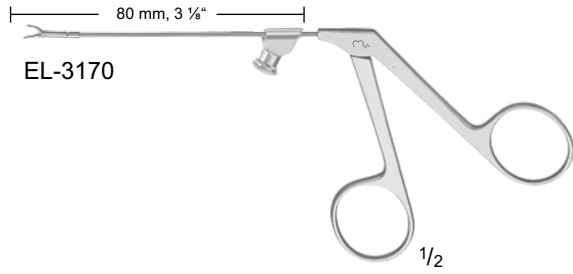

### MCGEE Wire Crimper

Catalog Number	Tip Size (mm)	Blade	Working Length (in.)
EL-3170	3.5	CVD-DOWN	3 1/8
EL-3171	5	CVD-DOWN	3 1/8

### GUILFORD-WRIGHT Wire Cutter

Catalog Number	Jaw	Length (in.)
EL-3172	SERR	3 3/8

### HOUSE Strut Guide

Catalog Number	Tip Size (mm)	Tip	Length (in.)
EL-3173	0.6	ANG	6 1/2

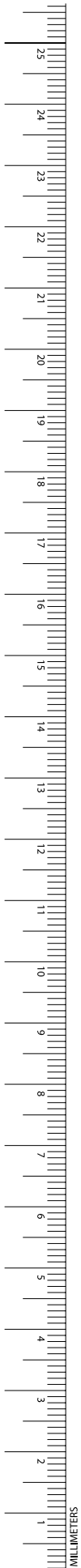

**ENT-EAR**  
Nippers/Crimping Forceps/Wire  
Guides/Cutters/Snares



**Ear Snare Wire, Pkg/100**

Catalog Number	Diameter (mm)
EL-3174	0.2



**KRAUSE Ear Snare, Extra Delicate**

Catalog Number	Length (in.)
EL-3175	6 1/4

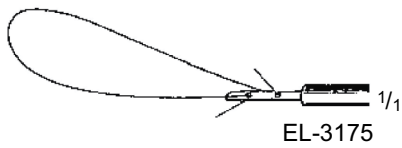

# ENT-EAR Hooks and Probes

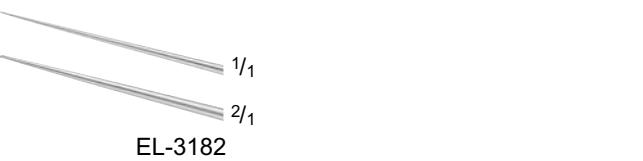
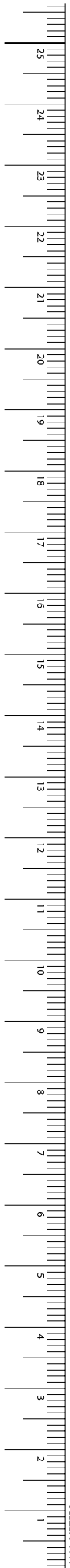

## DAY Ear Hook

Catalog Number	Size	Tip Size (mm)	Tip	Length (in.)
EL-3176	X-SMALL	1.5	ANG 90°	6 1/4
EL-3177	SMALL	2.0	ANG 90°	6 1/4
EL-3178	LARGE	2.5	ANG 90°	6 1/4

## HOUSE Hook Ear Hook

Catalog Number	Tip Size (mm)	Tip	Length (in.)
EL-3179	1	ANG 90° LEFT	6 5/8
EL-3180	1	ANG 90° RIGHT	6 5/8

## SAUNDERS-PAPARELLA Stapes Hook

Catalog Number	Tip Size (mm)	Tip	Tip Size (#)	Length (in.)
EL-3181	0.5	ANG 90°, MALLEABLE	9	6 1/2

## SCHUKNECHT Hook

Catalog Number	Tip Size (mm)	Tip	Length (in.)
EL-3182	0.4	ANG-UP, ANTERIOR	6 1/4
EL-3183	0.6	ANG-DOWN, POSTERIOR	6 1/4

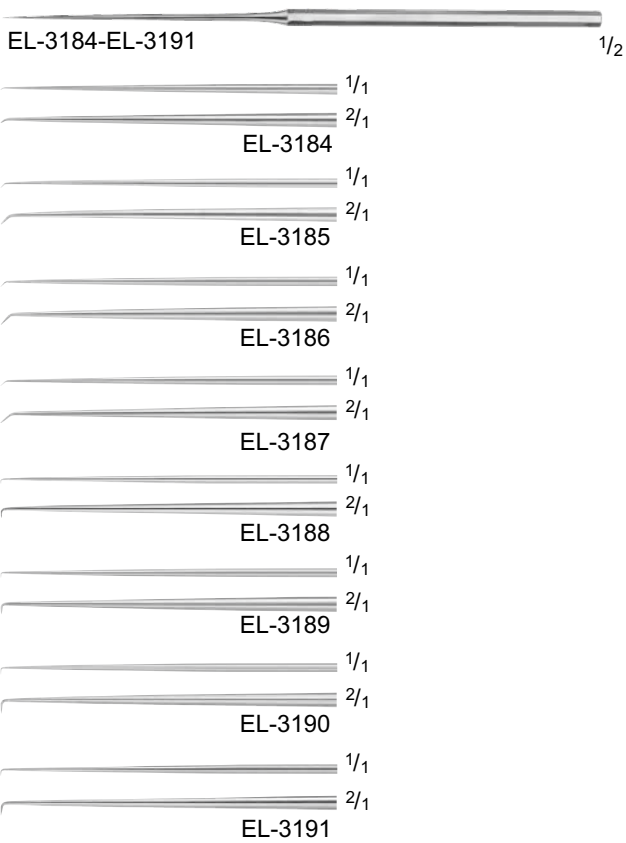

### SHAMBAUGH Fen Hook

Catalog Number	Tip Size (mm)	Angle	Length (in.)
EL-3184	0.4	45°	6 1/4
EL-3185	0.6	45°	6 1/4
EL-3186	0.8	45°	6 1/4
EL-3187	1.0	45°	6 1/4
EL-3188	0.4	90°	6 1/4
EL-3189	0.6	90°	6 1/4
EL-3190	0.8	90°	6 1/4
EL-3191	1.0	90°	6 1/4

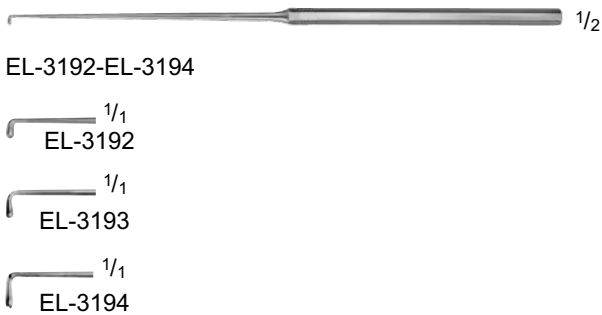

### LUCAE Ear Hook Button

Catalog Number	Size	Length (in.)
EL-3192	SMALL	5 1/2
EL-3193	MEDIUM	5 1/2
EL-3194	LARGE	5 1/2

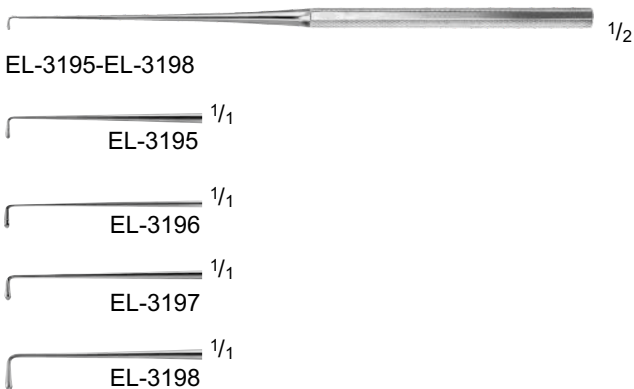

### WAGENER Nerve Hook Button

Catalog Number	Size	Length (in.)
EL-3195	X-SMALL	6
EL-3196	SMALL	6
EL-3197	MEDIUM	6
EL-3198	LARGE	6



## ENT-EAR Retractors

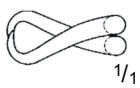
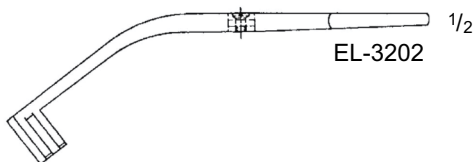
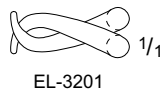
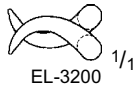
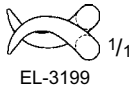
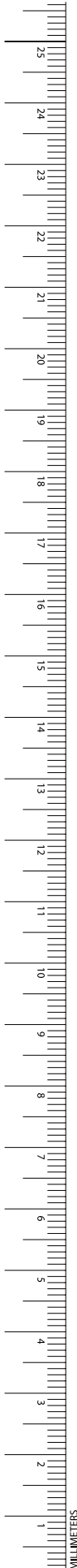

## JANSEN Retractor

Catalog Number	Tip	Blade End	Length (in.)
EL-3199	SHARP	3 x 3 PRONGS	4
EL-3200	BLUNT	3 x 3 PRONGS	4
EL-3201	BLUNT	3 x 3 PRONGS	4

## PLESTER-PAPARELLA-WEITLANER Retractor

Catalog Number	Tip	Blade End	Length (in.)
EL-3202	SHARP	2 x 2 PRONGS	5 1/8



EL-3203

1/2

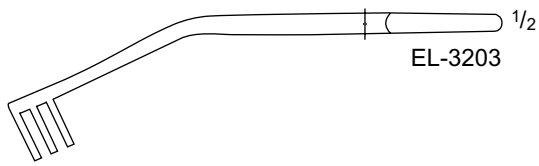

EL-3203

1/2

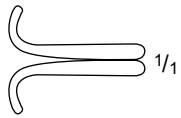

1/1

**SCHUKNECHT Retractor**

Catalog Number	Tip	Blade End	Length (in.)
EL-3203	ANG, SHARP	3 x 3 PRONGS	5 1/8



EL-3204

1/2

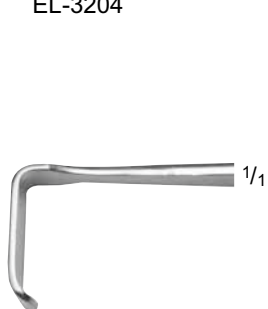

1/1



1/1

EL-3204

**HOUSE Hand Retractor, Double Ended**

Catalog Number	Blade Size (mm)	Length (in.)
EL-3204	20 x 7 / 25 x 9	6

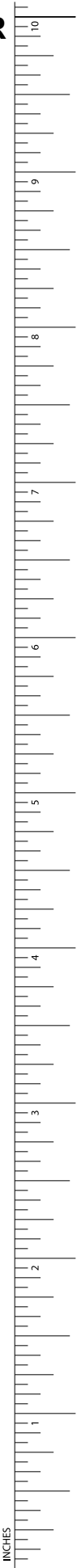



# ENT-EAR

## Picks

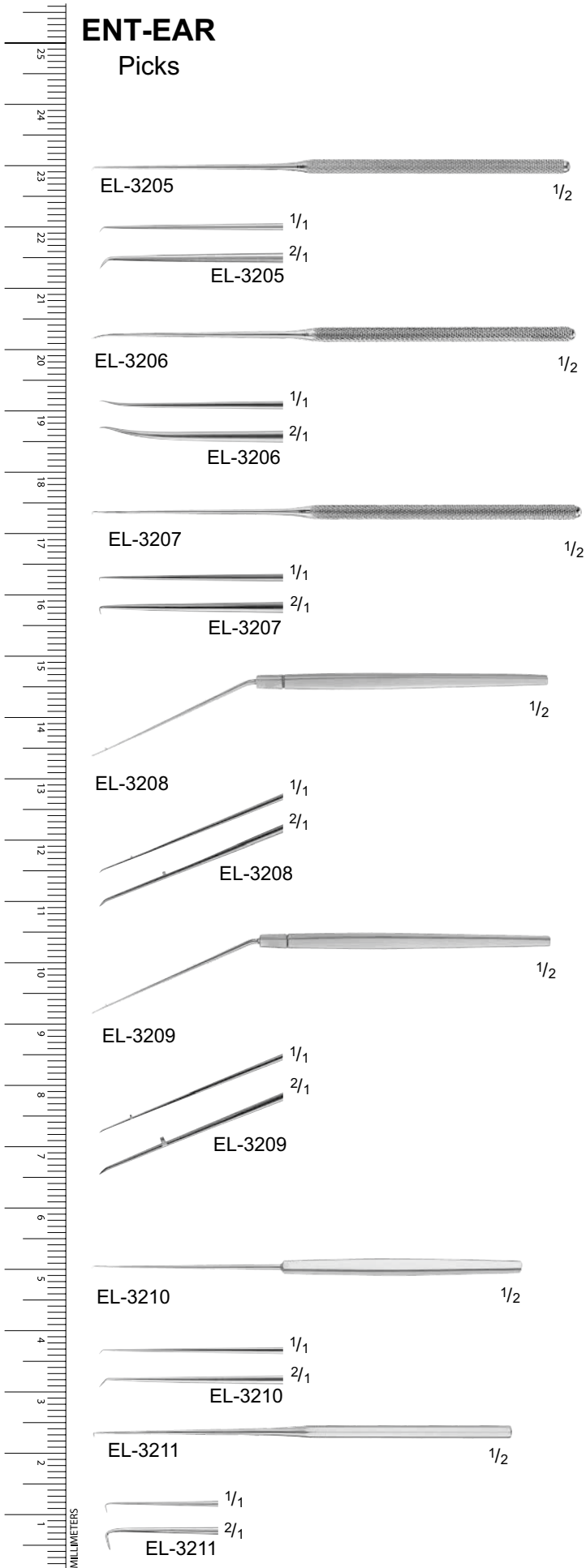

### AUSTIN Pick

Catalog Number	Tip Size (mm)	Tip	Length (in.)
EL-3205	1.0	ANG 45°	6 1/4

### BELLUCCI Pick

Catalog Number	Tip	Tip Size (mm)	Length (in.)
EL-3206	CVD POINT, 4 MM FROM TIP	-	6 5/8
EL-3207	ANG 90°	0.5	6 5/8

### FARRIOR Footplate Pick, with Notch

Catalog Number	Tip	Shaft	Length (in.)
EL-3208	ANTERIOR, CVD-RIGHT	ANG	5 7/8
EL-3209	POSTERIOR, CVD-LEFT	ANG	5 7/8

### GUILFORD-WRIGHT Footplate

Catalog Number	Tip Size (mm)	Tip	Length (in.)
EL-3210	0.5	ANG 45°	5 1/2

### GUILFORD-WRIGHT Stapes Pick, Heavy

Catalog Number	Tip	Length (in.)
EL-3211	ANG 90°	5 1/2

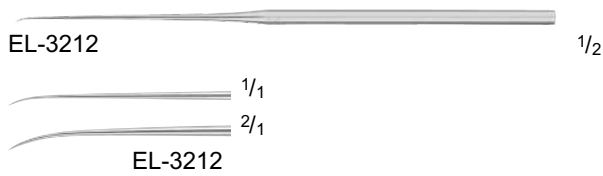

**HOUGH Footplate Pick**

Catalog Number	Tip	Length (in.)
EL-3212	CVD	5 7/8

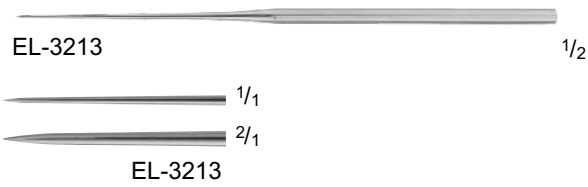

**HOUGH Pick**

Catalog Number	Tip	Length (in.)
EL-3213	STR	5 7/8

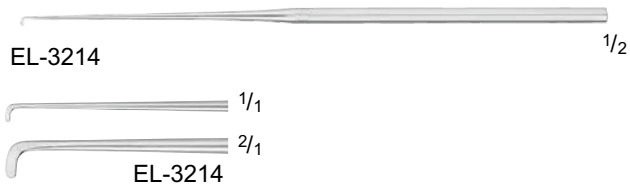

**HOUSE-CRABTREE Dissector Pick**

Catalog Number	Tip Size (mm)	Tip	Length (in.)
EL-3214	2.5	ANG 90°	6 5/8

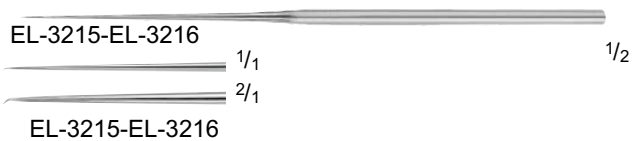

**HOUSE Oval Window Pick**

Catalog Number	Tip Size (mm)	Tip	Shaft	Length (in.)
EL-3215	0.33	ANG 30°	-	6 1/2
EL-3216	0.66	ANG 30°	-	6 1/2
EL-3217	0.33	ANG 90°	FINE	6 1/2
EL-3218	0.33	ANG 90°	MEDIUM	6 5/8

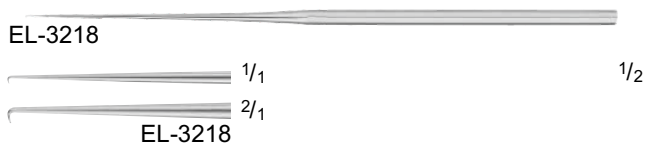
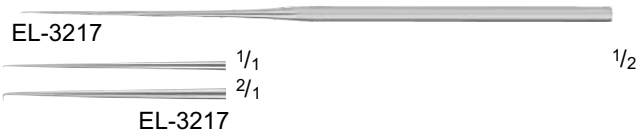

# ENT-EAR

## Picks

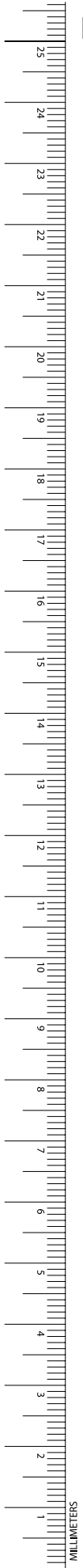

EL-3219-EL-3220 1/2

1/1

2/1

EL-3219

1/1

2/1

EL-3220

EL-3221 1/2

1/1

2/1

EL-3221

EL-3222 1/2

1/1

2/1

EL-3222

EL-3223 1/2

1/1

2/1

EL-3223

EL-3224 1/2

1/1

2/1

EL-3224

EL-3225 1/2

1/1

2/1

EL-3225

### HOUSE Strut Pick

Catalog Number	Tip Size (mm)	Tip	Length (in.)
EL-3219	0.5	ANG 90°	6 1/2
EL-3220	0.66	ANG 90°	6 1/2
EL-3221	0.75	ANG 90°	6 1/2
EL-3222	1.0	ANG 90°	6 1/2
EL-3223	1.5	ANG 90°	6 1/2
EL-3224	3.0	ANG 90°	6 1/2

### HOUSE-BARBARA Pick, Malleable

Catalog Number	Tip	Length (in.)
EL-3225	STR	6 1/2

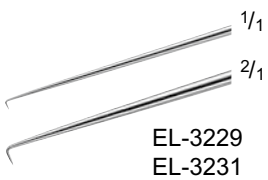

EL-3231

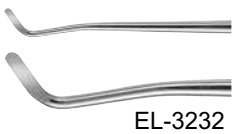

**KOS Pick, Bayonet-Shaped**

Catalog Number	Tip Size (mm)	Tip	Length (in.)
EL-3226	85	STR	7
EL-3227	-	ANG-UP 90°	7

**MCGEE Footplate Pick**

Catalog Number	Tip Size (mm)	Tip	Shaft	Length (in.)
EL-3228	0.2	ANTERIOR	ANG-UP	6 1/2
EL-3229	0.2	POSTERIOR	ANG-DOWN	6 1/2
EL-3230	1.0	ANTERIOR	ANG-UP	6 1/2
EL-3231	1.0	POSTERIOR	ANG-DOWN	6 1/2

**PAPPARELLA Pick**

Catalog Number	Tip Size (#)	Tip	Length (in.)
EL-3232	17	LEFT	6 1/2
EL-3233	16	RIGHT	6 1/2

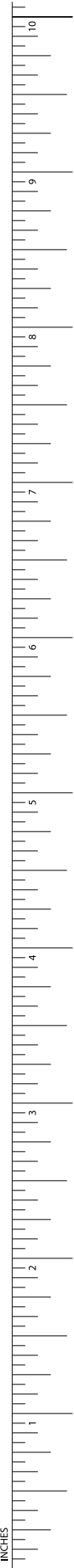

# ENT-EAR Specula and Holders

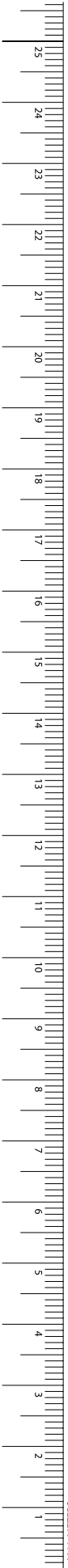

EL-3234-EL-3236

1/1



EL-3238-EL-3240

1/1

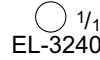
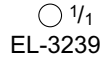
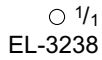

EL-3242-EL-3245

1/1

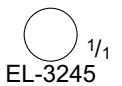
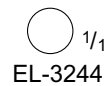
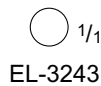
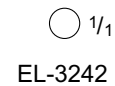

EL-3247-EL-3250

1/1

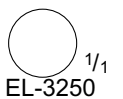
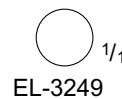
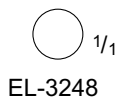
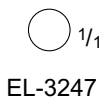

## Ear Speculum, Oval, Ebony

Catalog Number	Tip Size (mm)
EL-3234	4.5 x 5.5
EL-3235	5.5 x 6.5
EL-3236	6.5 x 7.5

## POLITZER Ear Speculum, Round, Pediatric

Catalog Number	Tip Size (mm)
EL-3237	SET OF 3 OF102C-OF104C
EL-3238	2
EL-3239	3
EL-3240	4

## BOUCHERON Ear Speculum, Round, Adult

Catalog Number	Tip Size (mm)
EL-3241	SET OF 4 OF121C-OF124C
EL-3242	4.2
EL-3243	5.2
EL-3244	6.2
EL-3245	7.2

## BOUCHERON Ear Speculum, Round, Large

Catalog Number	Tip Size (mm)
EL-3246	SET OF 4 MA077R-MA080R
EL-3247	5.5
EL-3248	6.6
EL-3249	7.5
EL-3250	9.0



EL-3252-EL-3255

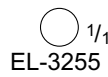
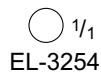
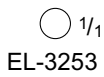

**BOUCHERON Ear Speculum, Round, Small**

Catalog Number	Size (#)	Tip Size (mm)
EL-3251	-	SET OF 4 MA072R-MA075R
EL-3252	1	3.0
EL-3253	2	4.0
EL-3254	3	4.5
EL-3255	4	5.0



EL-3256-EL-3265

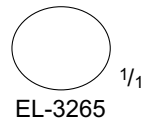
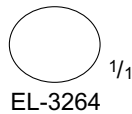
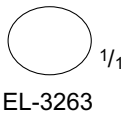
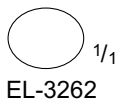
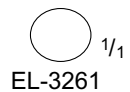
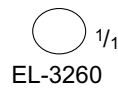
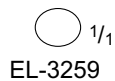
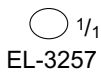

**FARRIOR Ear Speculum, Oval, Oblique**

Catalog Number	Size (#)	Tip Size (mm)
EL-3256	XX-SMALL	3 x 4
EL-3257	X-SMALL	4 x 5
EL-3258	-	SET OF 7 MA090R-MA096R
EL-3259	1	5 x 6
EL-3260	2	6 x 7
EL-3261	3	7 x 8
EL-3262	4	8 x 10
EL-3263	5	9 x 11
EL-3264	6	10 x 12
EL-3265	7	11 x 13



EL-3266-EL-3273

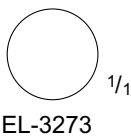
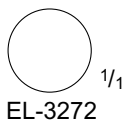
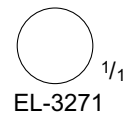
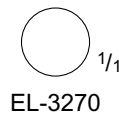
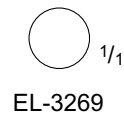
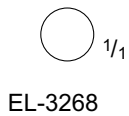
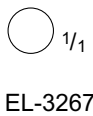

**FARRIOR Ear Speculum, Round, Oblique**

Catalog Number	Size (#)	Tip Size (mm)
EL-3266	-	SET OF 7 MA098R-MA104R
EL-3267	1	6
EL-3268	2	7
EL-3269	3	8
EL-3270	4	9
EL-3271	5	10
EL-3272	6	11
EL-3273	7	12

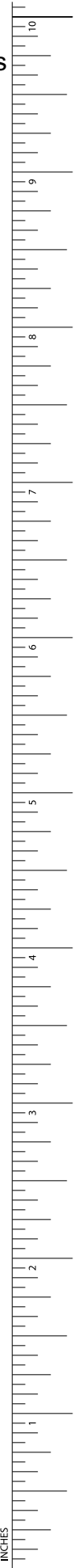

## ENT-EAR Specula and Holders

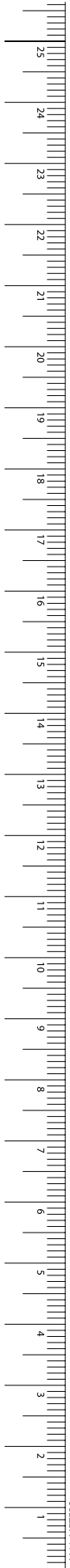

EL-3274-EL-3283

1/1



EL-3274



EL-3275



EL-3277



EL-3278



EL-3279

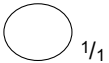

EL-3280



EL-3281



EL-3282



EL-3283



EL-3284-EL-3291

1/1



EL-3285



EL-3286



EL-3287



EL-3288



EL-3289



EL-3290



EL-3291

### FARRIOR Ear Speculum, Oval, Regular

Catalog Number	Size (#)	Tip Size (mm)
EL-3274	XX-SMALL	3 x 4
EL-3275	X-SMALL	4 x 5
EL-3276	-	SET OF 7 MA082R-MA088R
EL-3277	1	4.5 x 6
EL-3278	2	5.5 x 7
EL-3279	3	6.5 x 8
EL-3280	4	7.5 x 9
EL-3281	5	8 x 10
EL-3282	6	9 x 11.25
EL-3283	7	10 x 12.5

### FARRIOR Ear Speculum, Round, Regular

Catalog Number	Size (#)	Tip Size (mm)
EL-3284	-	SET OF 7 MA106R-MA112R
EL-3285	1	5.0
EL-3286	2	6.0
EL-3287	3	7.0
EL-3288	4	8.0
EL-3289	5	9.0
EL-3290	6	10.0
EL-3291	7	10.5



1/1

EL-3292-EL-3294

○ 1/1  
EL-3292

○ 1/1  
EL-3293

○ 1/1  
EL-3294

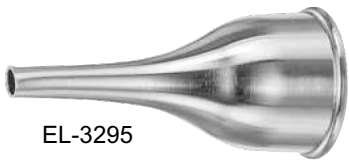

1/1

EL-3295

○ 1/1  
EL-3295

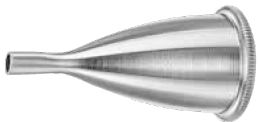

1/1

EL-3297-EL-3299

○ 1/1  
EL-3297

○ 1/1  
EL-3298

○ 1/1  
EL-3299



1/1

EL-3300-EL-3302

○ 1/1  
EL-3300

○ 1/1  
EL-3301

○ 1/1  
EL-3302

### GRUBER Ear Speculum, Oval, Infant

Catalog Number	Size (#)	Tip Size (mm)
EL-3292	SMALL	2.0 x 2.5
EL-3293	MEDIUM	2.5 x 3.0
EL-3294	LARGE	3.0 x 4.0

### GRUBER Ear Speculum, Oval, Infant, Long

Catalog Number	Tip Size (mm)
EL-3295	4.5 x 5.0

### GRUBER Ear Speculum, Oval, Light

Catalog Number	Size (#)	Tip Size (mm)
EL-3296	-	SET OF 3 MA119R-MA121R
EL-3297	1	1.6 x 2.4
EL-3298	2	2.4 x 3.2
EL-3299	3	3.2 x 4.7

### GRUBER Ear Speculum, Oval, Heavy, Long

Catalog Number	Size (#)	Tip Size (mm)
EL-3300	1	5 x 6
EL-3301	2	6 x 7
EL-3302	3	7 x 8

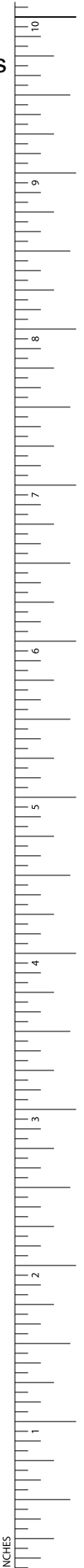



## ENT-EAR Specula and Holders

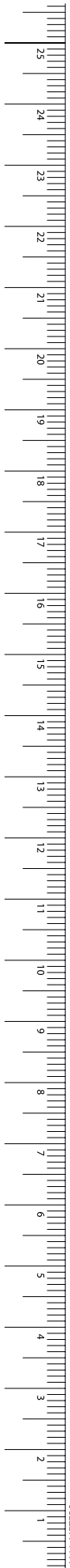

EL-3304-ER3306

1/16



EL-3304



EL-3305

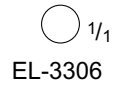

EL-3306



EL-3307

1/16



EL-3308-EL-3309

1/16



EL-3308

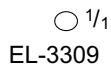

EL-3309



EL-3310-EL-3312

1/16



EL-3310



EL-3311

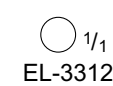

EL-3312



EL-3314-EL-3317

1/16



EL-3314



EL-3315

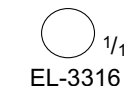

EL-3316

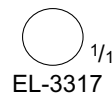

EL-3317

### GRUBER Ear Speculum, Round, Short, Light

Catalog Number	Size (#)	Tip Size (mm)
EL-3303	-	SET OF 3 MA125R-MA127R
EL-3304	1	3 x 33
EL-3305	2	4 x 35
EL-3306	3	5 x 37

### GRUBER Ear Speculum, Round, Long, Heavy

Catalog Number	Description
EL-3307	SET OF 3

### HARTMANN Ear Speculum, Infant

Catalog Number	Tip	Tip Size (mm)
EL-3308	ROUND	2.5
EL-3309	OVAL	2.5 x 3

### HARTMANN Ear Speculum, Infant

Catalog Number	Tip Size (mm)
EL-3310	1.8
EL-3311	3.2
EL-3312	4.6

### HARTMANN Ear Speculum, Oval

Catalog Number	Size (#)	Tip Size (mm)
EL-3313	-	SET OF 4 MA132R-MA135R
EL-3314	1	4.5 x 5.5
EL-3315	2	5.5 x 6
EL-3316	3	6.5 x 7
EL-3317	4	7.5 x 8



EL-3318-EL-3322 <sup>1/1</sup>



EL-3319



EL-3320



EL-3321



EL-3322

### HARTMANN Ear Speculum, Round, Adult

Catalog Number	Size (#)	Tip Size (mm)
EL-3318	-	SET OF 4 MA137R, MA650R-MA652R
EL-3319	1	4
EL-3320	2	5
EL-3321	3	6
EL-3322	4	7



EL-3323-EL-3326 <sup>1/1</sup>



EL-3323



EL-3324



EL-3325



EL-3326

### HARTMANN Ear Speculum, Round

Catalog Number	Tip Size (mm)
EL-3323	3.5
EL-3324	5.0
EL-3325	6.5
EL-3326	8.0



EL-3327 <sup>1/2</sup>

### SHEA Speculum Holder

Catalog Number	Length (in.)
EL-3327	11 3/4

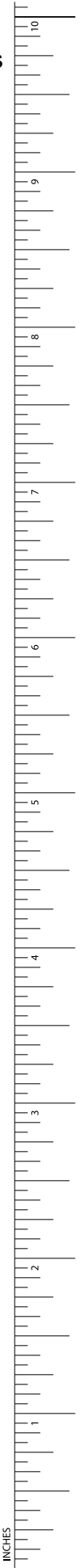

## ENT-EAR

### Applicators and Searchers

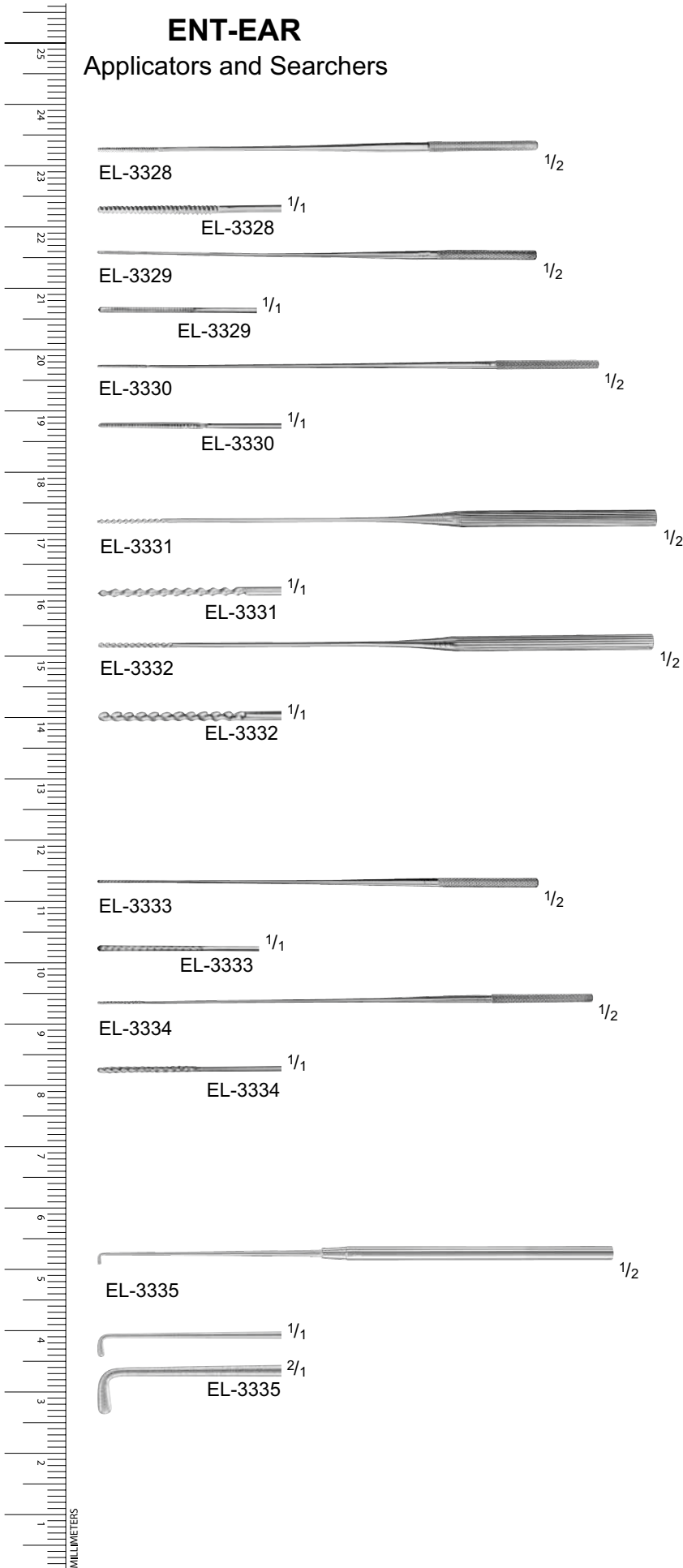

### LATHBURY-FARRELL Cotton Applicator, Triangular Serrated

Catalog Number	Tip Size (mm)	Length (in.)
EL-3328	0.9	5 1/2
EL-3329	1.4	5 1/2
EL-3330	1.2	6 1/4

### Cotton Applicator, Spiral

Catalog Number	Tip Size (mm)	Length (in.)
EL-3331	1.5	7
EL-3332	1.8	7

### FARRELL Cotton Applicator

Catalog Number	Tip Size (mm)	Tip	Length (in.)
EL-3333	1.2	ROUND-SERR	5 1/2
EL-3334	1.2	SPIRAL	6 1/4

### ALLPORT Mastoid Searcher

Catalog Number	Tip Size (mm)	Tip	Length (in.)
EL-3335	3	ANG 90°	6 3/4



**Ear Knife Handle, for Myringotomy Blades with Round Ends**

Catalog Number	Length (in.)
EL-3336	3 5/8

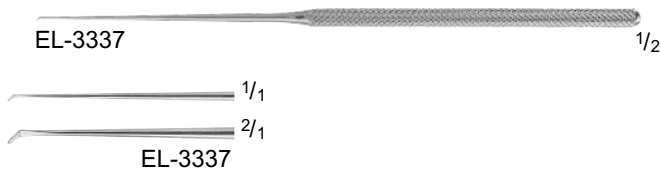

**AUSTIN Dissecting Knife**

Catalog Number	Blade Size (mm)	Blade Shape	Length (in.)
EL-3337	0.5	ANG 45°	6 1/4

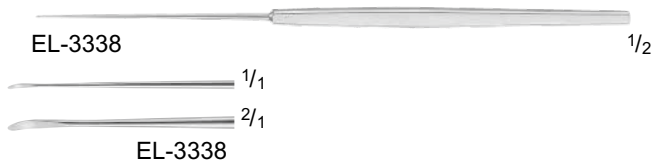

**DERLACKI Capsule Knife**

Catalog Number	Blade Size (mm)	Blade Shape	Length (in.)
EL-3338	0.25	ANG 20°	6 1/4
EL-3339	0.5	SLIGHT CVD	6 1/4

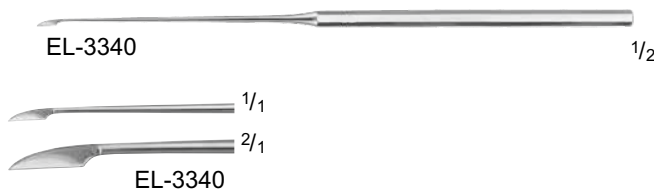
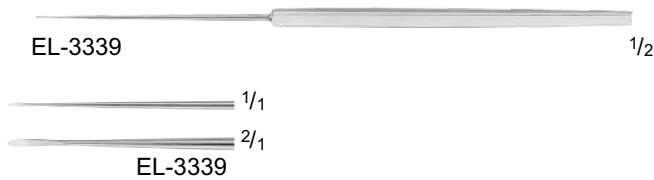

**Footplate Knife**

Catalog Number	Blade Shape	Length (in.)
EL-3340	STR	6 1/4

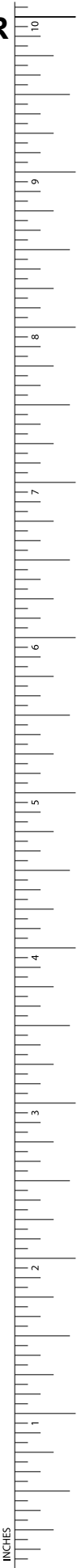

## ENT-EAR Knives

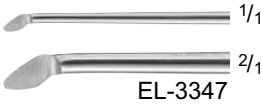
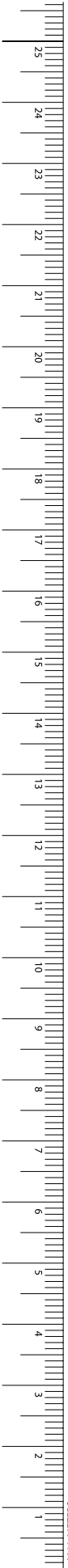

## GUILFORD-WRIGHT Flap Knife

Catalog Number	Blade Size (mm)	Length (in.)
EL-3341	3.6 x 2.5	6 1/4

## HARRISON Knives

Catalog Number	Size	Blade Shape	Length (in.)
EL-3342	SMALL	ANG 45°	6 1/8
EL-3343	SMALL	ANG 90°	6 1/8

## HOUSE Incudostapedial Joint Knife

Catalog Number	Blade Size (mm)	Blade Shape	Length (in.)
EL-3344	0.75	ANG 60°	6 5/8

## HOUSE Knife

Catalog Number	Blade Size (mm)	Blade Shape	Length (in.)
EL-3345	7.0	ANG LEFT	6 1/4
EL-3346	7.0	ANG RIGHT	6 1/4
EL-3347	2 x 3	ANG 45°	6 1/2
EL-3348	7.5	ANG 45°	6 1/2

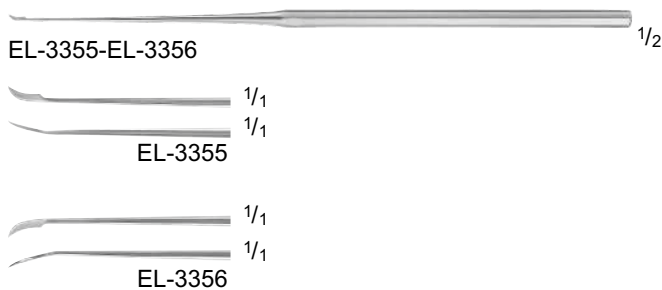
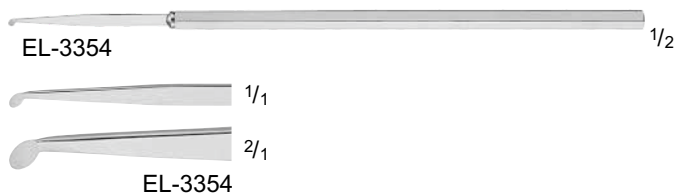
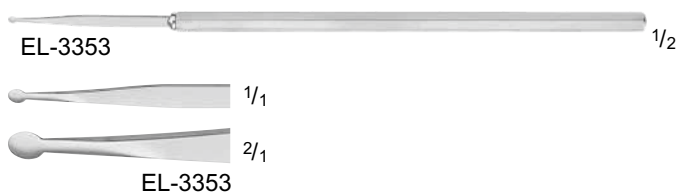
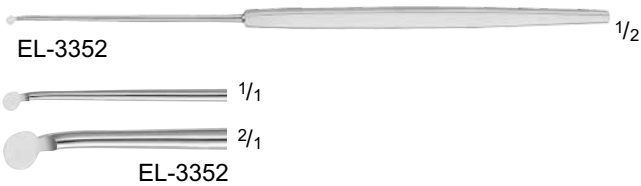
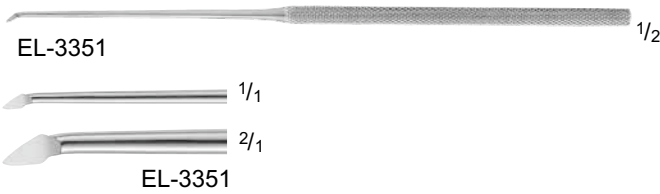
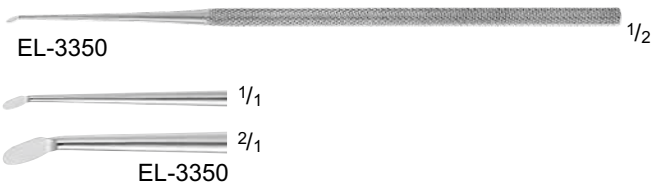
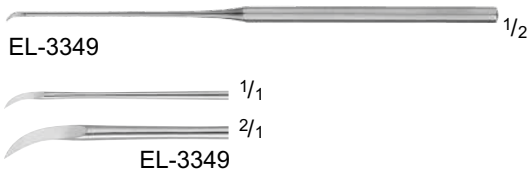

**GHANDI Knife, Sickle Blade**

Catalog Number	Blade Size (mm)	Length (in.)
EL-3349	4.0	5 1/8

**CULBERTSON Canal Knife**

Catalog Number	Tip Size (mm)	Length (in.)
EL-3350	1.4	6 1/4

**JORDAN Canal Knife**

Catalog Number	Blade Size (mm)	Blade Shape	Length (in.)
EL-3351	2 x 3	ANG 45°	6 1/2

**MCCABE Canal Knife**

Catalog Number	Blade Size (mm)	Blade Shape	Length (in.)
EL-3352	2.5	ANG 45°	6 1/4

**PAPARELLA Canal Knife**

Catalog Number	Size (#)	Blade Size (mm)	Blade Shape	Length (in.)
EL-3353	1	2	STR	6 1/2
EL-3354	2	2	STR	6 1/2

**PAPARELLA Sickle Knife**

Catalog Number	Size (#)	Blade Size (mm)	Blade Shape	Length (in.)
EL-3355	14	5	CVD RIGHT	6 1/2
EL-3356	15	5	CVD LEFT	6 1/2

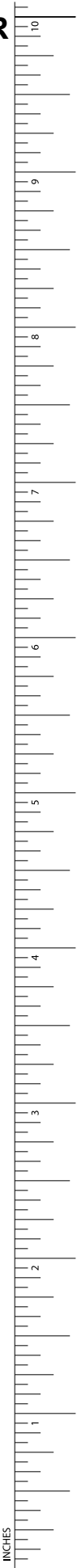

## ENT-EAR

### Knives

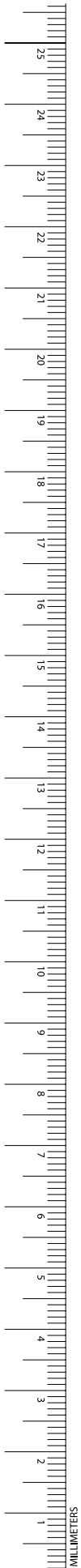

EL-3357

1/2



1/1

1/1



2/1

2/1

EL-3357



EL-3358

1/2



1/1

1/1

EL-3358



EL-3359

1/2



1/1



2/1

EL-3359



EL-3360

1/2



1/1



2/1

EL-3360



EL-3361

1/2



1/1



2/1

EL-3361



EL-3362

1/2



1/1



2/1

EL-3362

### MCCABE Knife Flap Dissector, Double Ended, Angled

Catalog Number	Blade Shape	Length (in.)
EL-3357	20° / 45°	7 1/4
EL-3358	20° / 40°	7 1/4

### MCHUGH Flap Knife

Catalog Number	Blade Shape	Length (in.)
EL-3359	OVAL	6 1/2

### Myringotomy Knife

Catalog Number	Blade Size (mm)	Blade Shape	Length (in.)
EL-3360	8	STR	6 1/2
EL-3361	9	CVD	6 1/2

### PLESTER Knife, Sickle Knife

Catalog Number	Blade Shape	Length (in.)
EL-3362	CVD	6 1/4

EL-3363-EL-3366

1/2

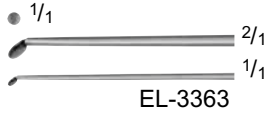

EL-3363



EL-3364



EL-3365



EL-3366

EL-3367

1/2



EL-3367

EL-3368

1/2



EL-3368



EL-3369



EL-3369

**Round Cutting Knife**

Catalog Number	Blade Size (mm)	Blade Shape	Length (in.)
EL-3363	1.5	45°	6 1/4
EL-3364	2.0	45°	6 1/4
EL-3365	2.6	45°	6 1/4
EL-3366	1.5	90°	6 1/4

**ROSEN Knife**

Catalog Number	Blade Size (mm)	Blade Shape	Length (in.)
EL-3367	-	SPEAR	6 1/4
EL-3368	2	45° UP ROUND	6 1/4

**ROYCE Ear Knife**

Catalog Number	Blade	Blade Size (mm)	Shaft	Length (in.)
EL-3369	DOWN-CUTTING	8	ANG	6 1/4

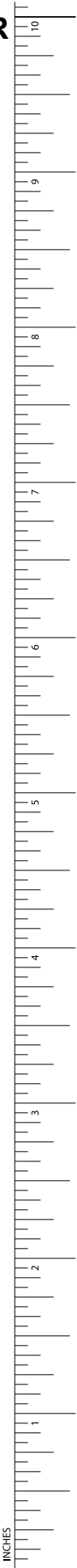



# ENT-EAR

## Knives

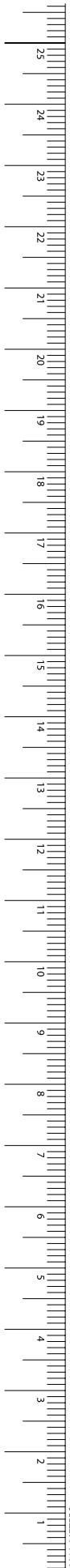

### SCHUKNECHT Roller Knife

Catalog Number	Blade Shape	Length (in.)
EL-3370	RIGHT-ANG	6 1/4
EL-3371	STR	6 1/4

### SHEEHY Knife Curette

Catalog Number	Size	Blade Size (mm)	Blade Shape	Length (in.)
EL-3372	SMALL	2.0	WEAPON	6 5/8
EL-3373	LARGE	2.5	WEAPON	6 5/8

### Sickle Knife

Catalog Number	Blade Tip	Blade Size (mm)	Blade Shape	Length (in.)
EL-3374	SHARP	10	CVD	7 1/2
EL-3375	BLUNT	10	CVD	7 1/2

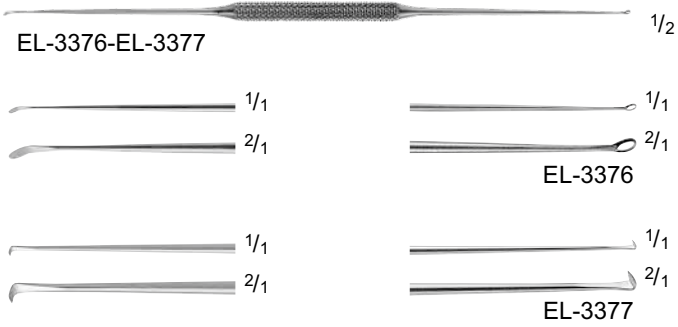

**TABB Flap Knife, Double Ended, Angle**

Catalog Number	Blade Size (mm)	Blade Shape	Length (in.)
EL-3376	0.9 / 1.0	25° / 45°	6 1/2
EL-3377	0.9 / 1.0	90° / 115°	6 1/2

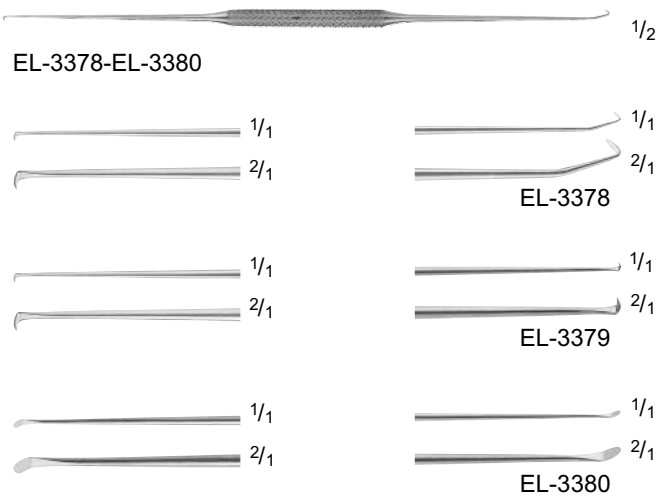

**TABB Myringotomy Knife, Double Ended, Angled**

Catalog Number	Blade Size (mm)	Blade Shape	Length (in.)
EL-3378	1.0 / 1.0	90° / 120°	6 1/4
EL-3379	1.3 / 1.3	90° / 115°	6 1/4
EL-3380	1.1 / 1.1	25° / 45°	6 1/4

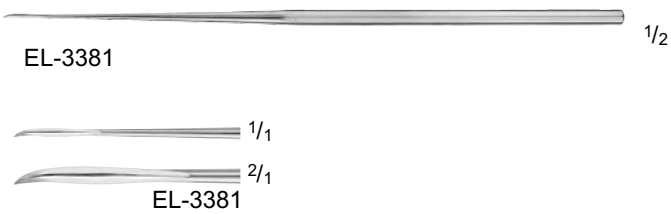

**HOUSE Tympanoplasty Knife**

Catalog Number	Blade Size (mm)	Blade Shape	Length (in.)
EL-3381	7	CVD	6 1/2



## ENT-EAR Suction Irrigation



EL-3382-EL-3383



EL-3384



EL-3385-EL-3387



EL-3388-EL-3390

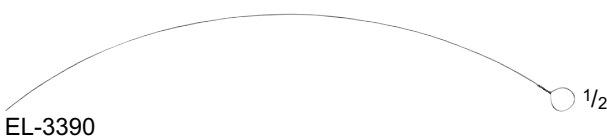

EL-3390

### ANTHONY Suction Tube, Straight

Catalog Number	Tip Size (mm)	Length (in.)
EL-3382	2 I.D.	6 1/8
EL-3383	3 I.D.	6 1/8

### BARNES Hospital Suction Tube

Catalog Number	Tip Size (FR)	Working Length (in.)	Length (in.)
EL-3384	9	3 3/4	6 1/8

### BARON Suction Tube

Catalog Number	Tip Size (FR)	Working Length (in.)	Length (in.)
EL-3385	3	4	4
EL-3386	5	4	4
EL-3387	7	4	4
EL-3388	3	2 3/4	5 1/2
EL-3389	5	2 3/4	5 1/2
EL-3390	7	2 3/4	5 1/2
EL-3391	-	-	6

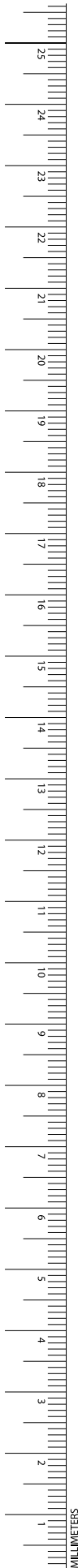

EL-3392



EL-3393



EL-3394



EL-3395



EL-3396

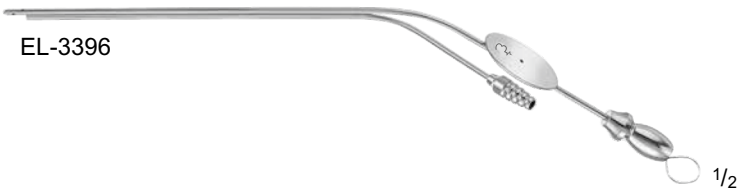

EL-3397

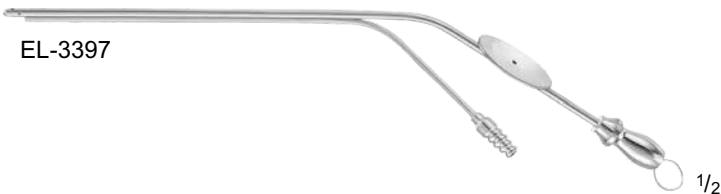

EL-3398-EL-EL-3400



### HOUSE-BARON Suction Tube, Long

Catalog Number	Tip Size (FR)	Working Length (in.)	Length (in.)
EL-3392	3	3 5/8	5 1/2
EL-3393	5	3 5/8	6 1/8

### BRACKMANN Suction Tube

Catalog Number	Tip Size (FR)	Working Length (in.)	Length (in.)
EL-3394	5	3	6
EL-3395	7	3	6
EL-3396	5	4 1/8	6
EL-3397	7	4 1/8	6

### HOUSE Suction Tube, Straight

Catalog Number	Tip	Length (in.)
EL-3398	18 GA	4 1/8
EL-3399	20 GA	4 1/8
EL-3400	22 GA	4 1/8



# ENT-EAR Suction Irrigation

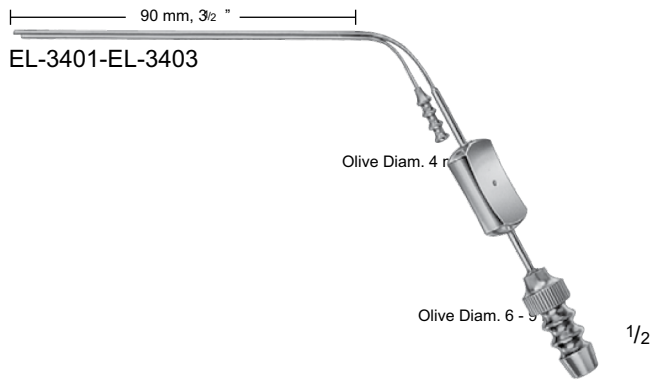

## HOUSE Suction Irrigation Cannula

Catalog Number	Tip Size (mm)	Working Length (in.)
EL-3401	0.9 / 0.7	3 1/2
EL-3402	1.2 / 0.9	3 1/2
EL-3403	1.5 / 1.2	3 1/2

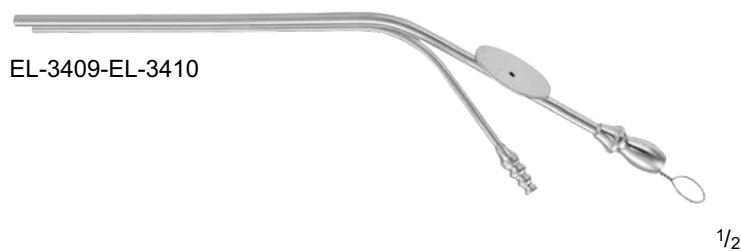

## WILLIAM-HOUSE Suction Irrigator

Catalog Number	Tip Size (FR)	Working Length (in.)	Length (in.)
EL-3404	2.5 x 4	2 3/4	4 1/2
EL-3405	4 x 5	3	4 1/2
EL-3406	2.5 x 4	3	5 1/2
EL-3407	5 x 7	3	5 1/2
EL-3408	6 x 8	3	5 1/2
EL-3409	7 x 10	3	5 1/2
EL-3410	8 x 12	3	5 1/2
EL-3411	12 x 14	3	5 1/2
EL-3412	2 x 2.5	3 3/8	5 1/8

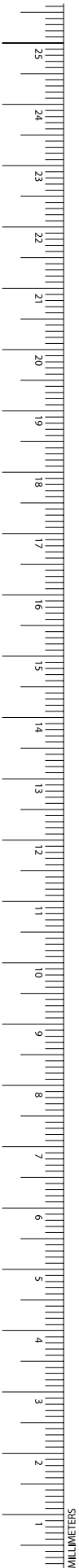

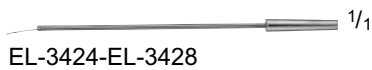
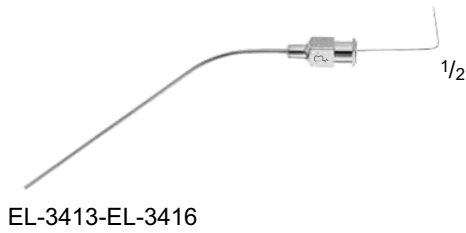

### Suction Tube

Catalog Number	Tip	Working Length (in.)	Length (in.)
EL-3413	18 GA	2 3/8	3 1/2
EL-3414	20 GA	2 3/8	3 1/2
EL-3415	22 GA	2 3/8	3 1/2
EL-3416	24 GA	2 3/8	3 1/2
EL-3417	14 GA	2 3/8	4
EL-3418	15 GA	2 3/8	4
EL-3419	16 GA	2 3/8	4
EL-3420	17 GA	2 3/8	4
EL-3421	19 GA	2 3/8	4
EL-3422	26 GA	2 3/8	4

### BELLUCCI Suction Tube, Detachable Tips

Catalog Number	Diameter (mm)	Description	Length (in.)
EL-3133	-	SET	-
EL-3423	8	SUCTION TUBE W/ FINGER CUT-OFF AND STYLET	6 1/8

### ZOELLNER Suction, Tips Only for GF770R

Catalog Number	Tip	Diameter (mm)
EL-3424	18 GA	1.2
EL-3425	20 GA	1.0
EL-3426	22 GA	0.7
EL-3427	24 GA	0.5
EL-3428	26 GA	0.4

### ZOELLNER Suction Tube

Catalog Number	Diameter (mm)	Length (in.)
EL-3429	2.5	7

### HOUSE Cut-OZ Adapter

Catalog Number	Length (in.)
EL-3430	2 1/4



## ENT-EAR

### Dissectors/Chisels/Gouges

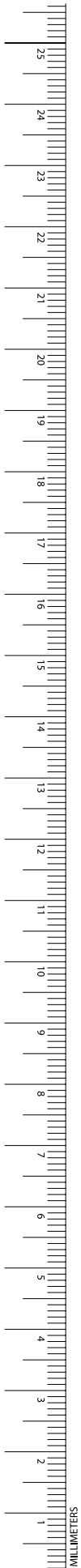

EL-3431-EL-3432



EL-3431

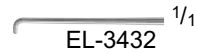

EL-3432

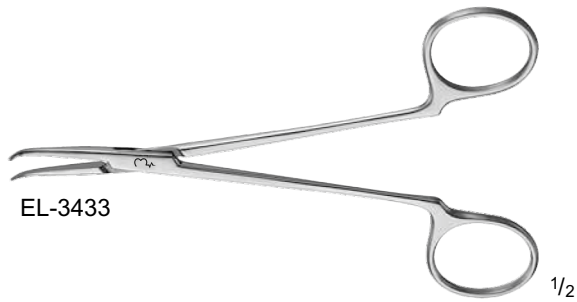

EL-3433



EL-3433



EL-3434



EL-3434



EL-3435



EL-3435



EL-3436



EL-3436



EL-3437



EL-3437



EL-3438



EL-3438

### CRABTREE "JIMMY" Dissector

Catalog Number	Tip Size (mm)	Tip	Length (in.)
EL-3431	1.3	SMALL	6 1/2
EL-3432	2.0	LARGE	6 1/2

### MCCABE Facial Nerve Dissector

Catalog Number	Tip Size (mm)	Jaw	Length (in.)
EL-3433	25	ANG	5 1/2

### DERLACKI Chisel

Catalog Number	Tip Size (mm)	Blade Shape	Length (in.)
EL-3434	0.5	STR	6 1/4
EL-3435	0.5	ANG 10°	6 1/4
EL-3436	0.5	ANG 20°	6 1/4

### HOUSE Footplate Chisel

Catalog Number	Tip Size (mm)	Blade Shape	Length (in.)
EL-3437	0.6	STR	6 1/4
EL-3438	0.6	SLIGHT-CVD	6 1/4

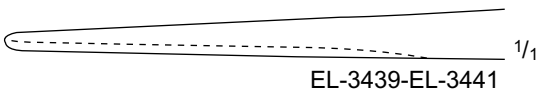

**BISHOP Mastoid Gouge**

Catalog Number	Tip Size (mm)	Length (in.)
EL-3439	3	6
EL-3440	4	6
EL-3441	5	6

**PARKES Hump Gouge, Double Guard**

Catalog Number	Tip Size (mm)	Length (in.)
EL-3442	6	7
EL-3443	10	7





## ENT-EAR

### Elevators/Scrapers/Excavators

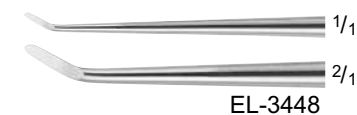
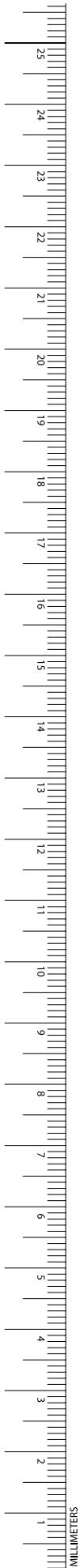

#### AUSTIN Duckbill Elevator

Catalog Number	Tip Size (mm)	Tip	Length (in.)
EL-3444	2	CVD	6 1/4

#### HOUSE Elevator, Angled

Catalog Number	Tip Size (mm)	Tip	Length (in.)
EL-3445	1	ANG	6 1/4

#### PAPARELLA Duckbill Elevator

Catalog Number	Tip Size (mm)	Size (#)	Length (in.)
EL-3446	3	18	6 1/2

#### GUILFORD-WRIGHT Drum Elevator, Angled

Catalog Number	Tip Size (mm)	Length (in.)
EL-3447	2	5 1/2

#### HOUGH Drum Scraper

Catalog Number	Tip Size (mm)	Tip	Length (in.)
EL-3448	0.5	ANG 45°	6 1/4

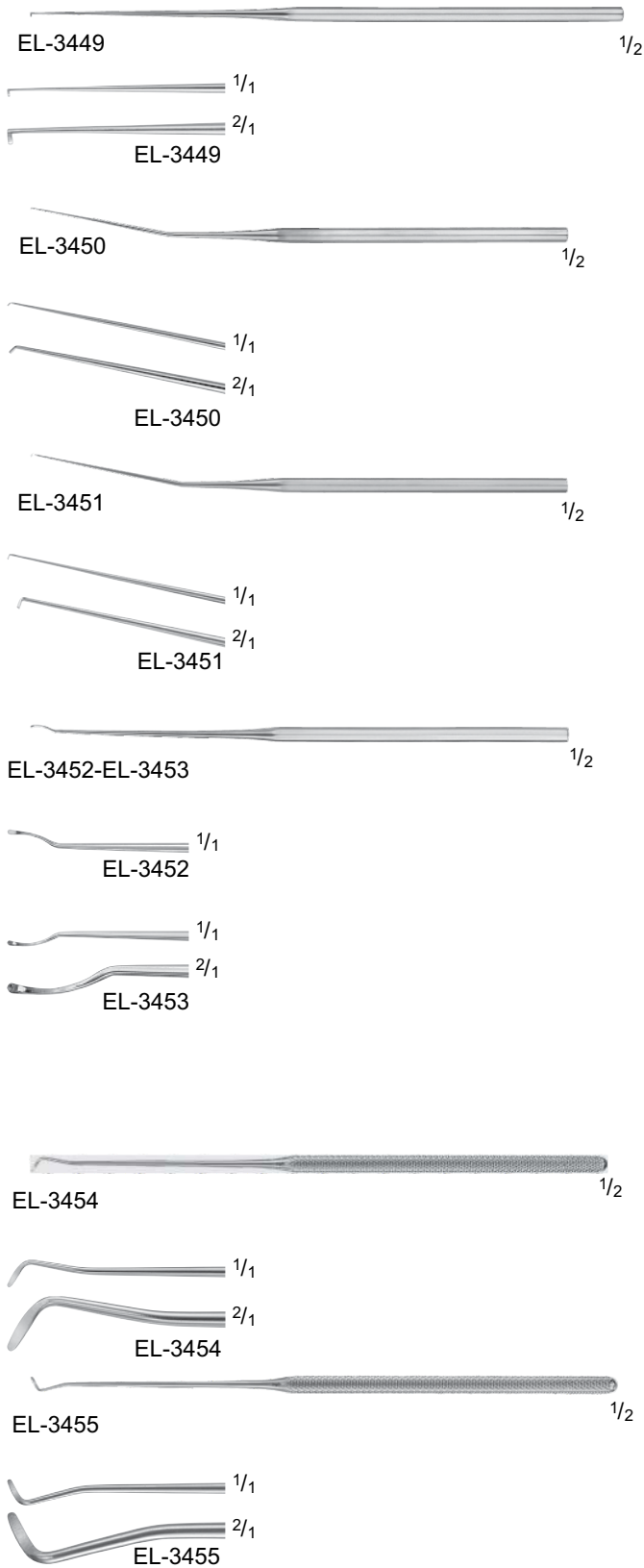

### HOUGH Excavator

Catalog Number	Tip Size (mm)	Tip	Length (in.)
EL-3449	0.33	ANG 30°	6 1/2
EL-3450	0.33	ANG 45°	6
EL-3451	0.33	ANG 90°	6

### HOUGH Whirlybird Excavator

Catalog Number	Tip Size (mm)	Tip	Length (in.)
EL-3452	0.7 x 3.0	CVD-LEFT	6
EL-3453	0.7 x 3.0	CVD-RIGHT	6

### AUSTIN Excavator

Catalog Number	Tip Size (mm)	Tip	Length (in.)
EL-3454	1	ANG LEFT	6 1/4
EL-3455	1	ANG RIGHT	6 1/4

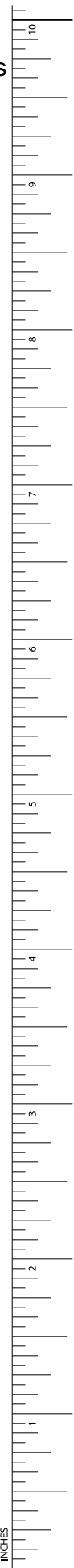

## ENT-EAR Augers/Measurers/Rasps

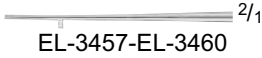
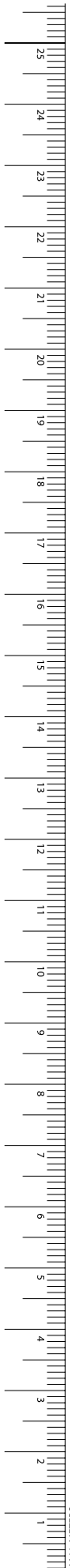

EL-3462-EL-3463



EL-3464

### HOUGH Footplate Auger Drill

Catalog Number	Tip Size (mm)	Tip	Length (in.)
EL-3456	0.8 x 20.0	DRILL	5 7/8

### HOUSE-STRUT Measuring Rod W/ Markers

Catalog Number	Tip Size (mm)	Description	Length (in.)
EL-3457	3.5	MEASURING ROD 3.5 MM FROM MARKET TO TIP	6 1/2
EL-3458	4.0	MEASURING ROD 4.0 MM FROM MARKET TO TIP	6 1/2
EL-3459	4.5	MEASURING ROD 4.5 MM FROM MARKET TO TIP	6 1/2
EL-3460	5.0	MEASURING ROD 5.0 MM FROM MARKET TO TIP	6 1/2

### Middle Ear Mirror

Catalog Number	Diameter (mm)	Tip	Length (in.)
EL-3461	2	ANG 45°	6 1/2

### MCGEE Oval Window Rasp

Catalog Number	Size	Length (in.)
EL-3462	SMALL	6 3/8
EL-3463	LARGE	6 3/8

### PAPARELLA Fenestrometer

Catalog Number	Blade Size (mm)	Tip Size (#)	Length (in.)
EL-3464	1 x 4	13	6 3/8



### BILLEAU Ear Loop

Catalog Number	Tip Size (mm)	Tip	Length (in.)
EL-3465	2	SMALL	6 3/8
EL-3466	2	MEDIUM	6 1/4
EL-3467	3	LARGE	6 1/4

### BUCK Ear Curette, Sharp, Curved

Catalog Number	Tip Size (#)	Cup Size (mm)	Length (in.)
EL-3468	00	1.0	6
EL-3469	00	1.5	6
EL-3470	0	2.0	6
EL-3471	1	2.5	6
EL-3472	2	3.0	6
EL-3473	3	4.0	6

### BUCK Ear Curette, Blunt, Curved

Catalog Number	Tip Size (#)	Cup Size (mm)	Length (in.)
EL-3474	00	1.0	6
EL-3475	00	1.5	6
EL-3476	0	2.0	6
EL-3477	1	2.5	6
EL-3478	2	3.0	6
EL-3479	3	4.0	6

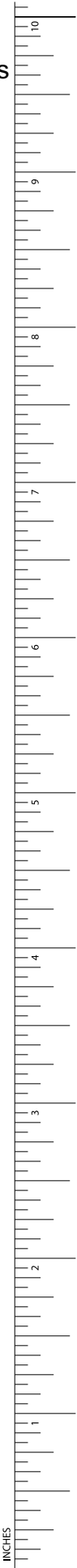

# ENT-EAR

## Curettes/Loops/Spoons

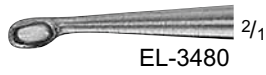
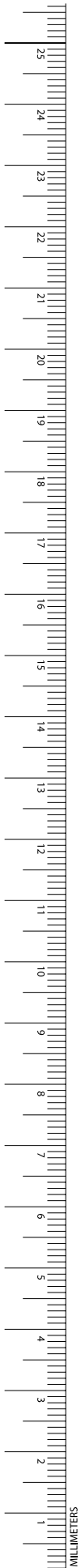

### HOUGH Ear Curette

Catalog Number	Cup Size (mm)	Tip	Size	Length (in.)
EL-3480	2.25 x 3 SERR	ANG 30°	LARGE	5 5/8

### GUILFORD-WRIGHT Ear Curette, Angled

Catalog Number	Cup Size (mm)	Size	Length (in.)
EL-3481	2.4 x 1.4	SMALL	5 1/8
EL-3482	2.5 x 3.0	MEDIUM	5 1/4

### SHEA Ear Curette, Round

Catalog Number	Cup Size (mm)	Blade	Length (in.)
EL-3483	2	ANG	5 1/2

### SHAPLEIGH Ear Curette, Angled

Catalog Number	Tip Size (mm)	Tip	Size	Length (in.)
EL-3484	1.5	SERR	SMALL	6 1/2
EL-3485	2.0	SERR	LARGE	6 1/2

## ENT-EAR

### Curettes/Loops/Spoons



#### FREIMUTH Ear Curette

Catalog Number	Cup Size (mm)	Tip	Size	Length (in.)
EL-3486	2.5 x 4	SERR	SMALL	6 1/4

#### SNELLEN Ear Curette

Catalog Number	Tip	Blade	Length (in.)
EL-3487	SERR	CVD	6 1/4

#### Ear Curette, Pointed, Double Ended

Catalog Number	Cup Size	Length (in.)
EL-3488	LARGE	6 3/4

#### HOUSE Ear Curette, Double Ended

Catalog Number	Cup Size (mm)	Tip	Length (in.)
EL-3489	1.0 / 1.2	ANG	6
EL-3490	1.5 / 1.8	ANG	6
EL-3491	1.0 / 1.2	STRONG ANG	6
EL-3492	1.5 / 1.8	STRONG ANG	6
EL-3493	2.0 / 1.7	LIGHT ANG	7
EL-3494	2.0 / 2.25	STRONG ANG	7

# ENT-EAR

## Curettes/Loops/Spoons

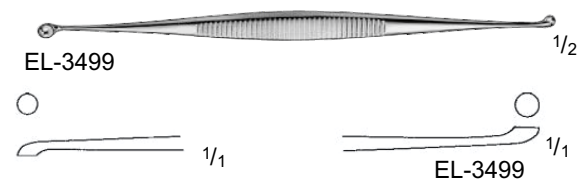
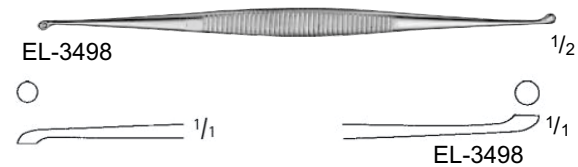
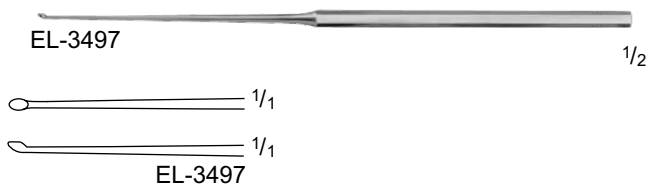
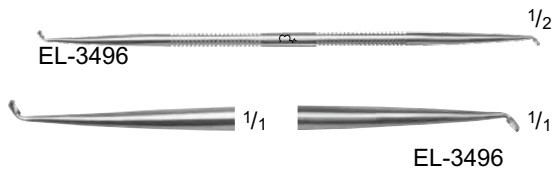

### HOUSE-PAPARELLA Stapes Ear Curette, Double Ended

Catalog Number	Cup Size (mm)	Length (in.)
EL-3495	1.6 x 3.0 / 2.0 x 3.5	6 1/4

### HOUSE Stapes Curette, Double Ended

Catalog Number	Cup Size (mm)	Length (in.)
EL-3496	1.8 x 2.5 / 1.5 x 2.4	6

### SHEA Bone Curette, Oval

Catalog Number	Cup Size (mm)	Blade	Length (in.)
EL-3497	1.5 x 2.5	STR	6 1/4

### MARTINI Bone Curette, Double Ended

Catalog Number	Cup Size (mm)	Length (in.)
EL-3498	3.0 / 3.2	5 1/2
EL-3499	4.0 / 3.2	5 1/2

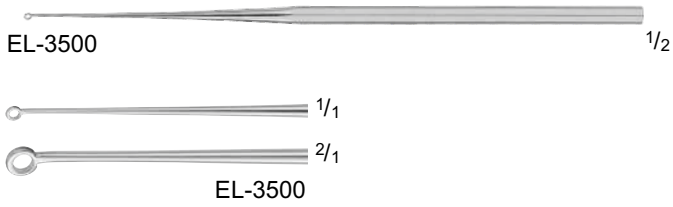

**PAPARELLA Ring Curette**

Catalog Number	Cup Size (#)	Blade	Length (in.)
EL-3500	12	ANG	6 1/2



**PRATT Ethmoid Curette, Double Ended**

Catalog Number	Blade	Length (in.)
EL-3501	SOLID/FENESTRATED	9 1/4

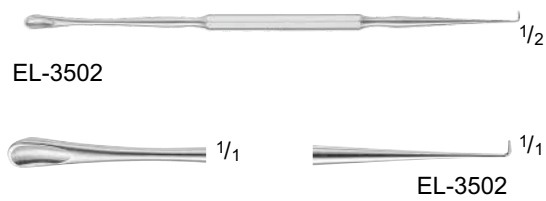

**GROSS Ear Hook/Spoon, Double Ended**

Catalog Number	Hook	Spoon	Length (in.)
EL-3502	90° BLUNT 2.6 MM	3.2 x 7.5 MM	5 1/4





**ENT-EAR**  
Rongeurs

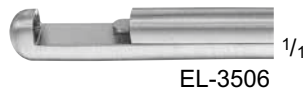
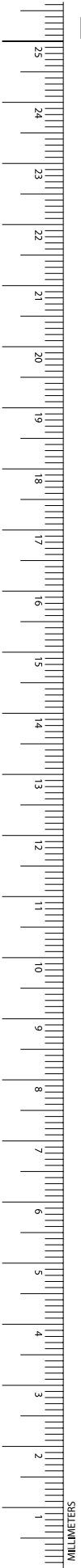

**KERRISON Mastoid Rongeur, 90° Up**

Catalog Number	Tip Size (#)	Jaw Size (mm)	Working Length (in.)	Length (in.)
EL-3503	0	3.5 x 9	4 1/8	6 3/4
EL-3504	1	4.0 x 9	4 1/8	6 3/4
EL-3505	2	4.5 x 9	4 1/8	6 3/4
EL-3506	3	5.0 x 9	4 1/8	6 3/4

$\frac{1}{2}$



EL-3508-EL-3513

**HARTMANN Tuning Fork**

Catalog Number	Frequency
EL-3507	c 64
EL-3508	c 128
EL-3509	c1 256
EL-3510	c2 512
EL-3511	c3 1024
EL-3512	c4 2048
EL-3513	c5 4096

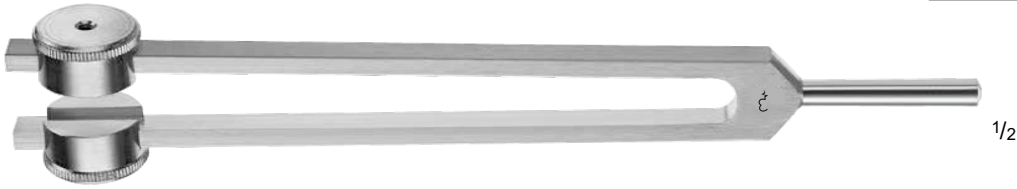

EL-3507



**ENT-EAR**  
Miscellaneous

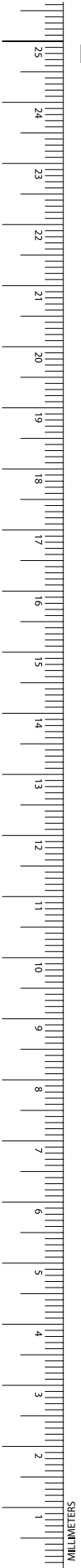

**SHEEHY Fascia Press**

Catalog Number	Jaw Size (mm)	Jaw	Description	Length (in.)
EL-3514	23 x 31	PLATE	W/ RATCHET BOX LOCK	7 1/2



**HOUSE Gelfoam Press, with Ratchet**

Catalog Number	Jaw Size (mm)	Jaw	Length (in.)
EL-3515	12 x 15	PLATE	5 3/8
EL-3516	12 x 16	PLATE	7





**HOUSE Cutting Block, Delrin**

Catalog Number	Dimensions (mm)	Description	Length (in.)
EL-3517	8 x 38	AUTOCLAVABLE	2 7/8



**Surgery Preparation Base W/ mm Scale**

Catalog Number	Dimensions (mm)
EL-3518	92 x 54





All rights reserved. Technical alterations are possible. This leaflet may be used for no other purposes than offering, buying and selling of our products. No part may be copied or reproduced in any form. In the case of misuse, we retain the rights to recall our catalogues and price lists and to take legal actions.